

Aerosols from Biomass Combustion

Thomas Nussbaumer (Ed.)

International Seminar
at 27 June 2001 in Zurich (Switzerland)
organised on behalf of

International Energy Agency (IEA)
BioenergyTask 32: Biomass Combustion and Cofiring

and the

Swiss Federal Office of Energy

ISBN 3-908705-00-2

ISBN 3-908705-00-2

Copyright © Verenum (Switzerland) 2001

Thomas Nussbaumer (Ed.): Aerosols from Biomass Combustion,
International Seminar at 27 June 2001 in Zurich by IEA Bioenergy Task
32 and Swiss Federal Office of Energy, Verenum, Zurich 2001

Addresses for orders

Verenum, Langmauerstrasse 109, CH - 8006 Zürich, verenum@access.ch

ENET, Egnacherstrasse 69, CH - 9320 Arbon, enet@temas.ch

IEA Bioenergy Task 32, c/o TNO-MEP, P.O. Box 342, NL - 7300 AH Apeldoorn
<http://www.ieabioenergy-task32.com>

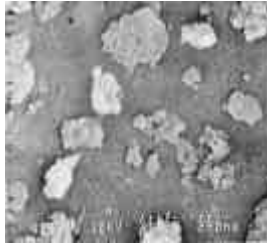

Aerosols from Biomass Combustion

Thomas Nussbaumer (Ed.)

International Seminar
at 27 June 2001 in Zurich (Switzerland)
organised on behalf of

International Energy Agency (IEA)
BioenergyTask 32: Biomass Combustion and Cofiring

and the

Swiss Federal Office of Energy

ISBN 3-908705-00-2

Preface

Biomass contributes with more than 10 % to the global energy supply. It is the main renewable energy source nowadays and for the near future. While by many biomass has been regarded as a traditional fuel with oil, coal and gas being modern fuels, the opposite view may be more correct. The main drive for renewed attention for bioenergy is the fact that it can significantly contribute to the reduction of CO₂ emissions in the atmosphere under attractive economic conditions. Other advantages are local job employment and reduction of dependency on import of fossil fuels. For such reasons, bioenergy is supported in many national and international programmes worldwide. Several bioenergy technologies are rapidly being developed and commercialised to convert the chemical energy stored in biomass into heat, electricity and other energy carriers.

As compared to other thermal conversion technologies, combustion technologies are proven and commercially available. However, biomass combustion can be a significant source of aerosol emissions and fine particles in the ambient air. For this reason, many countries consider the reduction of aerosols from biomass combustion as one of the priority research areas for bioenergy.

The Bioenergy Agreement within the International Energy Agency provides a platform to exchange information on the results of bioenergy research programmes amongst its member countries. The Seminar on Aerosols from Biomass Combustion has been jointly organised by the IEA Biomass Combustion and Cofiring Task and the Swiss Federal Office of Energy. International experts presented the knowledge on the environmental impact of aerosols, the formation mechanisms, the measurement technologies, and the measures for aerosol reduction. The seminar attracted 50 participants from 11 countries (CH, NL, A, DK, FI, S, N, UK, GER, USA, AUS). It was shown, that aerosol reduction from biomass combustion is an important issue. While many institutes are involved in research on aerosols, industry shows only little efforts for technology improvement and development so far. Since efficient solutions at low cost are not available yet, the reduction of aerosols from biomass combustion will remain a challenge for the future.

We hope that the seminar contributes to an exchange of information and that research and development will enable significant improvements in aerosol reduction.

Sjaak van Loo

PD Dr. Thomas Nussbaumer

Task Leader IEA Bioenergy Task 32
Biomass Combustion and Cofiring
TNO-MEP (The Netherlands)

Chairman of the Seminar
Delegate in the IEA Bioenergy Task 32
Verenum (Switzerland)

Table of Contents

No	Title	Page
1	Th. Nussbaumer: Relevance of aerosols for the air quality in Switzerland	1
2	Ch. Braun: Health effects of aerosols	11
3	H. Burtscher: Sampling, measurement, and characterization of combustion aerosols for chemistry, morphology, and size distribution	19
4	H. Livbjerg: Aerosol formation from straw combustion	29
5	J. Jokiniemi et al.: Modelling and experimental results on aerosol formation, deposition and emissions in fluidized bed combustion of biomass	31
6	F. Ebert: Particle separation for biomass combustion	41
7	C. Tullin et al.: Overview of projects on aerosols from biomass combustion in Sweden	47
8	L. Baxter: Investigations on aerosols from biomass in the United States	51
9	Ch. Ehrlich et al.: Overview of investigations on aerosols from combustion (including biomass) in Germany	53
10	M. Oser et al.: Influences on aerosol emissions in an automatic wood furnace	59
11	L. Lilleblad et al.: Investigation of aerosol formation and cleaning efficiency in commercially operated biomass fired boilers	65
12	I. Obernberger et al.: Characterisation and formation of aerosols and fly-ashes from fixed-bed biomass combustion	69
13	Th. Brunner et al.: Measurement and analyses of aerosols formed during fixed-bed biomass combustion	75
14	Ch. Gaegauf et al.: Field investigation of nanoparticle emissions from various biomass combustion systems	81
15	L. Johansson et al.: Particulate emissions from small-scale biomass combustion	87
16	V. Schmatloch et al.: Small particles from combustion of wood logs in a wood stove	93
17	Discussion and Conclusions	97

RELEVANCE OF AEROSOLS FOR THE AIR QUALITY IN SWITZERLAND

T. Nussbaumer

Verenum, Langmauerstrasse 109, CH – 8006 Zurich, Switzerland
phone +41 (0)1 364 14 12, fax +41 (0)1 364 14 12, email verenum@access.ch

ABSTRACT: Switzerland has implemented ambient air quality standards on PM 10 (particulate matter < 10 μm) in 1998. The annual average standard of 20 $\mu\text{g}/\text{m}^3$ and the daily standard of 50 $\mu\text{g}/\text{m}^3$ are often and substantially exceeded not only in the cities, but also in suburban and rural areas. A reduction of approximately 50 % of the aerosol immissions is needed to meet the immission limits. As a consequence, a reduction of aerosols is necessary from the relevant sources.

The wood furnaces – as major application of energy production from biomass – cover 2.4 % of the total energy demand in Switzerland. Their contribution to the *total aerosols* is estimated at 3.9 %. Since only part of the aerosols originate from combustion, their contribution to *combustion aerosols* is even higher. 90 % of the aerosols from furnaces in households originate from wood furnaces, although wood contributes with less than 10 % to household heating. Following, the life cycle assessment (LCA) of different heating systems shows, that the environmental impact of wood combustion results mainly from NO_x and PM 10. The advantage of CO_2 neutrality of wood in comparison to oil and gas is at least partly compensated by the higher emissions of NO_x and PM 10.

The goal of future research, development, and implementation is to reduce the negative environmental effect of biomass combustion for energy production, i.e. reduction of NO_x and PM 10. Concerning aerosols, formation mechanisms as well as precipitation technologies are of interest for further improvements. The dominant part of aerosols from biomass burnt under good combustion conditions is typically in the submicron range between 0.05 μm and 0.2 μm . Since separation by inertia as in cyclones has an poor efficiency close to zero for this type of aerosols, additional measures are necessary to achieve a significant reduction.

Primary measures aim at a reduction of particle number and particle mass during combustion. Although the particle concentration can be influenced by operation conditions (e.g. by the excess air ratio) or the furnace design (e.g. optimised combustion chamber) in a certain range, primary measures which enable a significant reduction are not available. On the one hand, further research is needed to recognize the potential of primary measures. On the other hand, preliminary results indicate that primary measures will not be sufficient. Hence improved secondary measures for the reduction of submicron particles from biomass combustion are also of interest. Since cost and operation of available components are not competitive for most biomass plants nowadays, it is necessary to adopt precipitation technologies or to develop alternative concepts for the specific needs of biomass combustion. Among the available technologies, fabric filters show a high particle separation efficiency and a potential for the removal of further pollutants such as HCl and PCDD/F.

Keywords: Aerosol, particulate emissions, air quality, immission limit, life cycle assessment.

1. INTRODUCTION

1.1 Definition of aerosols

Aerosols are defined as a suspension of particles and droplets in the size range between 0,001 μm and 100 μm in a surrounding gas phase. The total mass of particles and droplets is indicated as *particulate matter (PM)*.

Since fine particles smaller than 10 μm are only partly precipitated in the nose, they can be inhaled and transported to the human lungs. Hence the particle fraction PM 10 (particulate matter < 10 μm) is commonly used nowadays for the definition of immission limits. The number indicates the aerodynamic particle diameter in μm according to a separation efficiency of 50 % in the sampling system. Further PM 2.5 and PM 1 are also used. Beside this, the *total suspended particulate matter (TSP)*

was used earlier. This particle fraction is defined as fine particulate matter with a setting velocity of less than 10 cm/s [1].

When emission limits are defined, the expressions *particulate emissions* or *total dust particles* [1] are commonly used and defined by the sampling of *all* particles (and droplets) which are precipitated on a filter with a defined separation efficiency close to 100 %.

Since PM 10 are of major concern for the human health, and biomass combustion mainly leads to particulate emissions smaller than 10 μm , this fraction of aerosols is also the topic of ongoing investigations an the present seminar. As it has been shown in many investigations, the main fraction of the particulate matter in the flue gas is even smaller than 1 μm . As a consequence, most investigations focus on submicron particles.

1.2 Main sources of aerosols from biomass combustion

Aerosols from incomplete combustion. Aerosols from biomass can be a result of an incomplete combustion such as soot, polycyclic aromatic hydrocarbons (PAH), unburnt carbon, and of unburnt biomass fragments. In simple combustion systems and/or under unfavourable combustion conditions, the mass fraction of unburnt particles can reach more than 90 % of the total particle mass, while it can drop to less than 1 % under good combustion conditions. Hence one of the main aims is to design and operate combustion devices which enable an almost complete combustion.

Aerosols from complete combustion. Aerosols are also formed in a complete combustion

- a) from mineral matter (ash components) which lead to components such as KCl, K₂SO₄, CaO, Al₂O₃, SiO₂, and
- b) as a result of contaminants (e.g. Cl and heavy metals present in urban waste wood (Altholz)) which can lead to additional emissions of heavy metals, HCl and PCDD/F.

Although all types of aerosols will be discussed in the seminar, focus will be given on uncontaminated fuels and the aerosols generated thereof.

2. AEROSOL IMMISSIONS IN SWITZERLAND

2.1 Air quality situation and aims

Air pollution control in Switzerland is based on the Ordinance on Air Pollution Control (OAPC) introduced in 1985 [1]. The OAPC defines two measures, i.e. *immission limits* on the one hand and *emission limits* on the other hand.

Immission limits exist for the main relevant pollutants such as CO, SO₂, NO₂, VOC, heavy metals, ozone, particulate matter and others. The immission limits are based on the air quality concept, which aims in immission levels as in 1950 for all air pollutants, except for NO₂ for which 1960 is assumed as reference year. The corresponding limit values are regarded as a reference with an acceptable air pollution. If one of the immission limit is exceeded, additional measures must be implemented, e.g. lower emission limits or traffic limitations. Such measures can be regional or national, depending on the effect of the relevant pollutant.

To meet the immission limit on SO₂, the sulfur content in light fuel oil and diesel oil was significantly reduced in the past twenty years. In the meantime, the SO₂ emissions in Switzerland were reduced to 25 % of the peak value in 1980 and hence the immission limit value is safely met [2]. The limit values on CO, heavy metals and several other substances are also met thanks to improved technologies such as advanced flue gas cleaning in municipal solid waste (MSW) incinerators, three-way catalysts in Otto engines etc. [2].

However, the levels of ozone and NO₂ are still significantly above the immission limits. Hence the efforts of the Swiss government and the Swiss Federal Office of Environment, Landscape, and Forestry (BUWAL) in the

past twenty years were focussed on the reduction of NO_x and VOC as precursors of ozone and NO₂ [2,3].

2.2 Contribution of particles to air pollution

The immission limits for particles defined as total suspended particles (TSP) in OPAC 1985 were not exceeded or only locally of relevance. As a result of this immission limit, additional measures for aerosol reduction were not of high priority until 1998.

The situation changed, when new findings on the relevance of fine particles for health and environment [4,5] lead to the introduction of new and more rigid immission limits on particles in 1998. The limit values for TSP were replaced by limit values for PM 10 as follows: A maximum annual average of 20 µg/m³ and a maximum daily average of 50 µg/m³ (Table 1). The daily average must not be exceeded during more than once per year.

2.3 Immission limits on particles in different countries

Table 1 shows the limit values in different countries. In the USA, the PM 10 limits are higher than in Switzerland by a factor 2 to 3. However, USA has introduced limit values for PM 2.5 in 1997. With respect to the typical relation between PM 2.5 and PM 10, the limit values in Switzerland and USA lead to similar effects.

The indicative limit values from the European Community, which are planned to be introduced by 2010, are comparable to the limits valid in Switzerland as well.

Table 1: Immission limits on PM 10 (USA: PM 2.5) in different countries [3].

Country	Annual limit value µg/m ³	Daily limit value µg/m ³
Switzerland	20	50 (1 exceed p.a.)
USA	50	150 (99% for 3 a)
USA PM 2.5	15	65 (98% for 3 a)
California	30	50
United Kingdom	50 (99.9% / 2005)	–
Norway	40	70
EC to 1.1.2005	40	50 (35 exceed p.a.)
EC from 1.1.2010 (indicative value)	20	50 (7 exceed p.a.)

2.4 Actual situation

Table 2 gives a summarized overview on the air quality situation in comparison to the above defined immission limits. As indicated, there is no need for further reduction for SO₂ and CO. While NO₂ is of major concern in cities, ozone is a major problem in suburban and rural areas. The particle immissions indicated by TSP until 1997 did not reveal a major problem. However, the PM 10 limit introduced in 1998 clearly shows an essential need of improvement, since the PM 10 limit is often or substantially exceeded in all areas, i.e. urban, suburban and rural areas. As a result, approximately 54 % of the Swiss population is faced with exceeded immission limits on PM 10.

The consequences of the air pollution have been estimated recently by an international investigation for the Swiss Federal Office of Environment. It showed that in Switzerland 3300 persons die yearly due to air pollution [6]. Since more than 50 % of the air pollution effects are related to traffic, around 1650 deaths per year are due to traffic induced air pollution (0.02 % p.a. for a population of approximately 7 · 10⁶). In relation to approximately 600 to 700 lethal accidents annually, the death rate from traffic induced air pollution is 2 to 3 times as high as from accidents and it corresponds to 0.24 death p.a. per 1000 inhabitants. Further, the health cost resulting from air pollution are estimated to 6.77 · 10⁹ CHF p.a. (= 4.5 · 10⁹ Euro) or CHF 1000 per capita p.a.. Hence air pollution is a relevant problem for health, environment, and economy in Switzerland.

Table 2: Air quality situation in Switzerland in the year 2000 [2,3].

	Cities, urban areas	Suburban areas	Rural areas
SO ₂	○	○	○
CO	○	○	○
NO ₂	●	◐	◐
Ozone (O ₃)	◐	●	●
TSP 10 (until 1997)	◐	○	○
PM 10 (since 1998)	●	●	●

Legend:

- Immission limits met nearly everywhere
- ◐ Immission limits partly exceeded
- Immission limits often/substantially exceeded

Table 3: Population in Switzerland which is faced with exceeded immission limits [3].

	Number of persons with exceeded immission limits	% of population	year
NO ₂	2.1 Mio	31%	1995
PM 10	3.7 Mio	54%	1993
Ozone (O ₃)	6.8 Mio	100%	1994

2.5 Needs for aerosol reduction

To meet the immission limits on PM 10 in Switzerland, a reduction of approximately 50 % of the PM 10 concentration in the ambient air is necessary [3]. As a consequence, major sources of fine particles and precursors of atmospheric aerosols need to be reduced significantly.

3. CONTRIBUTION OF BIOMASS COMBUSTION TO AEROSOL IMMISSIONS

The contribution of different sources to the total PM 10 emissions in Switzerland was estimated as part of an emission inventory [7,8]. A summary of these data are given in Table 4.

The major sectors which contribute to PM 10 are traffic, industry, agriculture and forestry, and households. The electric power supply is not a relevant source of aerosols in Switzerland, because it is based on hydro and nuclear power.

Wood combustion in furnaces contributes to approximately 3.9 % of the total PM 10 emissions in Switzerland but only to 2.4 % of the total energy demand [3]. Hence wood combustion leads to PM 10 emissions above average of all energy systems.

Since wood is mainly used for heat production, it has to compete with fuel oil and natural gas. Although wood contributes with less than 10 % to household heating, 90 % of the PM 10 emissions from household furnaces result from wood. The same is true for furnaces in craft, while for furnaces in industry, also other relevant sources like coal and heavy oil exist.

The total of all wood furnaces contribute to 1252 tons of PM 10 p.a. which corresponds to the share of 3.9%. Beside this, there are some other sources of PM 10 which are also partly related to biomass combustion, i.e.:

- garden and hobby (households)
- waste combustion (industry)
- agriculture and forestry.

Biomass combustion related to these sources has no or only a minor economic value, since there is no or only a limited energetic utilization of the heat. Hence a reduction of PM 10 emissions from biomass combustion should aim at two measures:

Aerosols from Biomass Combustion

1. **Avoid biomass combustion without energetic utilization** like
 - illegal combustion of wood residues and waste wood on building sites and in open fires,
 - combustion of forestry wastes and other biomass in open fires,
 - combustion of waste wood in MSW incineration plants without energy production or with low efficiency

2. **Reduce PM 10 emissions from biomass combustion** in furnaces
 - by primary measures and if necessary
 - by secondary measures.

The reduction of aerosols from biomass combustion in furnaces is a challenge for technical improvement and the motivation for the present seminar and exchange of experiences.

Since illegal combustion of biomass and wastes is also an important source of PM 10 (and additionally of other harmful emissions such as heavy metals and PCDD/F), measure 1 can lead to a significant overall reduction of PM 10. The main tools are non-technical measures like information (which is not sufficient as only measure), improvement of waste management, and changes of economic boundary conditions.

Table 4: Emission inventory for PM 10 in Switzerland 1995 [7,8] with contribution of wood furnaces [3]. Explanations: BA = business & administration. Contributions marked with „->“ partly result from biomass combustion (such as wood burning in gardens, agriculture and forestry, biomass contained in waste) but not from wood furnaces.

Sector	Source	Sector		Source		Wood furnaces	
		[t/a]	[%]	[t/a]	[%]	[t/a]	[%]
Traffic		13 924	43.3				
Electric power supply		113	0.4				
Household		1 264	3.9				
	Furnaces			793	2.5	710	2.2
	-> Garden, hobby			122	0.4	-	-
	others			350	1.1		
Industry, craft, BA		10 045	31.3				
	Furnaces industry			547	1.7	192	0.6
	Furnaces craft, BA			377	1.2	350	1.1
	Stones, cement			1206	3.8		
	Petrochemistry			43	0.1		
	Metal			806	2.5		
	Food			327	1.0		
	-> Waste			1760	5.5	-	-
	Building trade			4486	14.0		
	Plastics			231	0.7		
	others			262	0.7		
Agriculture & Forestry	->	6794	21.1			-	-
Total		32140	100				
Total wood furnaces						1 252	3.9

4. CONTRIBUTION OF PM 10 TO ENVIRONMENTAL IMPACT OF WOOD FURNACES

The dominant application of wood combustion is heat production for room heating and process heat, while power production from biomass is of minor importance until nowadays. Hence wood furnaces are in competition with boilers for light fuel oil and natural gas. Furthermore, wood furnaces can be an alternative or an addition to heat pumps and solar energy for room heating.

To enable an overall comparison of the environmental impact of typical applications of room heating, a detailed life cycle assessment (LCA) for wood, oil, and gas has been carried out in Switzerland recently [9]. The LCA takes into account the emissions during exploitation, refinery, storage, transportation, and combustion of the different fuels.

Table 5 shows the results according to the ecological scarcity method (ECM). A comparison of the totals shows that the environmental impact of wood is lower than of light oil but higher than for natural gas (with oil / wood / gas = 1.3 / 1 / 0.76). A comparison by the method of eco-indicator leads to similar conclusions. Hence significant improvements in the wood chain are necessary to justify the funding of wood furnaces by an ecological motivation. However it is also evident that these conclusions are valid only for a certain assumption of the importance of the greenhouse effect. The data in table 5 are valid for the base case for the greenhouse effect according to [9]. If the

greenhouse effect is assumed as more or less important, the ranking changes as a result of the different CO₂ impacts of the three fuels.

Further, the LCA indicates that 38.6 % of the environmental impact of a modern automatic wood furnace is attributed to NO_x, 36.5 % due to PM 10, only 2 % due to CO₂ and 22.9 % due to all other pollutants. As expected, oil and gas show a completely different distribution, since CO₂ plays a dominant role for fossil fuels. For wood furnaces, a sustainable forestry management is assumed and hence the CO₂ increase from wood combustion is assumed to be zero. The only CO₂ contribution for wood is a result of electricity and diesel oil used in the production chain.

Table 6 shows a comparison of the particulate emission factors. Wood combustion leads to particulate emissions of 109 mg/MJ collectible energy at the chimney which is a factor of 1000 more than from oil and gas. If the particulate emissions of the whole life cycles are compared, the difference is still a factor of 10 in comparison to oil and a factor of 20 in comparison to gas.

Since wood furnaces lead to far higher emissions of NO_x and PM 10 than oil or gas boilers, the reduction of these two emissions is of high priority to improve the environmental advantages of wood as energy source. For other biomass fuels, the emissions of NO_x and PM 10 are even higher than for wood and hence the needs for reduction are even stronger.

Table 5: Environmental impact points (EIP) according to the ecological scarcity method for heating systems with wood, light oil and natural gas [9]. The data for wood correspond to wood chips; log wood leads to app. 10% higher values. For wood, modern automatic furnaces and the use of non contaminated wood fuel is assumed, while for oil and gas combustion modern low-NO_x boilers are assumed. The data in the table represent the base case of greenhouse effect according to [9].

	Wood		Oil		Gas	
	[EIP/GJ]	[%]	[EIP/GJ]	[%]	[EIP/GJ]	[%]
NO _x	13 030	38.6%	6 190	13.8%	3 410	13.0%
PM 10	12 600	36.5%	650	1.5%	130	0.5%
CO ₂	670	2.0%	18 200	40.7%	13 300	50.9%
SO _x , NH ₃ , CH ₄ , NMVOC, primary energy, residues, and others	8 200	22.9%	19 760	44.0%	9 260	35.6%
Total	34 500	100%	44 800	100%	26 100	100%
Total compared to wood		100%		130%		76%

Table 6: Particulate emission factors for heating systems with wood, light oil and natural gas in mg per MJ *collectible* energy [9]. To calculate from end energy (input energy by heating value) to collectible energy (heat to the heating system), an annual efficiency of 65% is assumed in [9], hence the emission factor for wood is assumed as $(109 \times 0.65 = 71)$ * mg per MJ *end* energy.

Particulate emission in [mg/MJ collectible energy]	Wood	Oil	Gas
Emissions from combustion	109 (71)*	0.106	0.103
Emission from fuel supply	5.29	8.22	3.82
Indirect emissions from plant construction and operation	2.71	1.53	1.91
Total	117	9.86	5.84

5. INVESTIGATIONS ON AEROSOLS IN SWITZERLAND

Due to the relevant environmental impact of PM 10, the Swiss Federal Office of Energy and the Swiss Federal Office of Environment have funded different research and development activities which aimed in lowering these emissions in the past 10 to 15 years. A brief overview on some investigations on aerosols from biomass combustion is presented. Ongoing activities are presented in separate contributions at the seminar.

5.1 Particle size and characteristics of aerosols

Since the particle size has a strong influence on the potential effect of aerosols and also on the separation capability, the particle size and the particle size distribution were analysed in several investigations [10,11,12,13,14,15,16,17,18]. One of the major finding is, that typically more than 80 % of the particulate emissions under good combustion conditions are smaller than 1 µm. The particle size is usually unimodal with a maximum of the number distribution around 0.1 µm in the range between 50 nm and 200 nm. Further, the influence of different operation parameters such as excess air ratio, combustion temperature, fuel type, etc. were investigated. In part of the investigation, also shape, morphology and composition of particles were analysed [10,11,12,13,15,16]. Further,

specific differences between wood, miscanthus, and straw were investigated [15,16,19].

5.2 Particulate emissions of wood furnaces in practice

Although many experiences on particulate emissions exist, the situation of automatic furnaces in practice was not clearly known. Hence a study of existing data from official approval tests from wood furnaces during the past 5 years was carried out recently [20], Figure 1. The study included mainly data from automatic wood furnaces < 5 MW with multi cyclones for particle precipitation. Additionally, data from log wood boilers were used. The goals of the study were to investigate whether significant influences on fuel type, plant size, or furnace type on particulate emissions were found in practise. Furthermore, these data will be used as a basis for decisions on future emission limits. The results show a certain trend with increasing particulate emissions from log wood boilers to understoker furnaces and finally grate furnaces. The average emission factors are 34 mg/MJ end energy for log wood boilers, while automatic furnaces with cyclones emit approximately 70 mg/MJ end energy (table 7). These values from measurements in practice confirm the assumption used for the LCA in [9] with average emissions of 71 mg/MJ end energy. However an annual efficiency of 75 % is assumed in study [20] in comparison to 65 % in [9], thus leading to slightly different values in mg/MJ collectible energy.

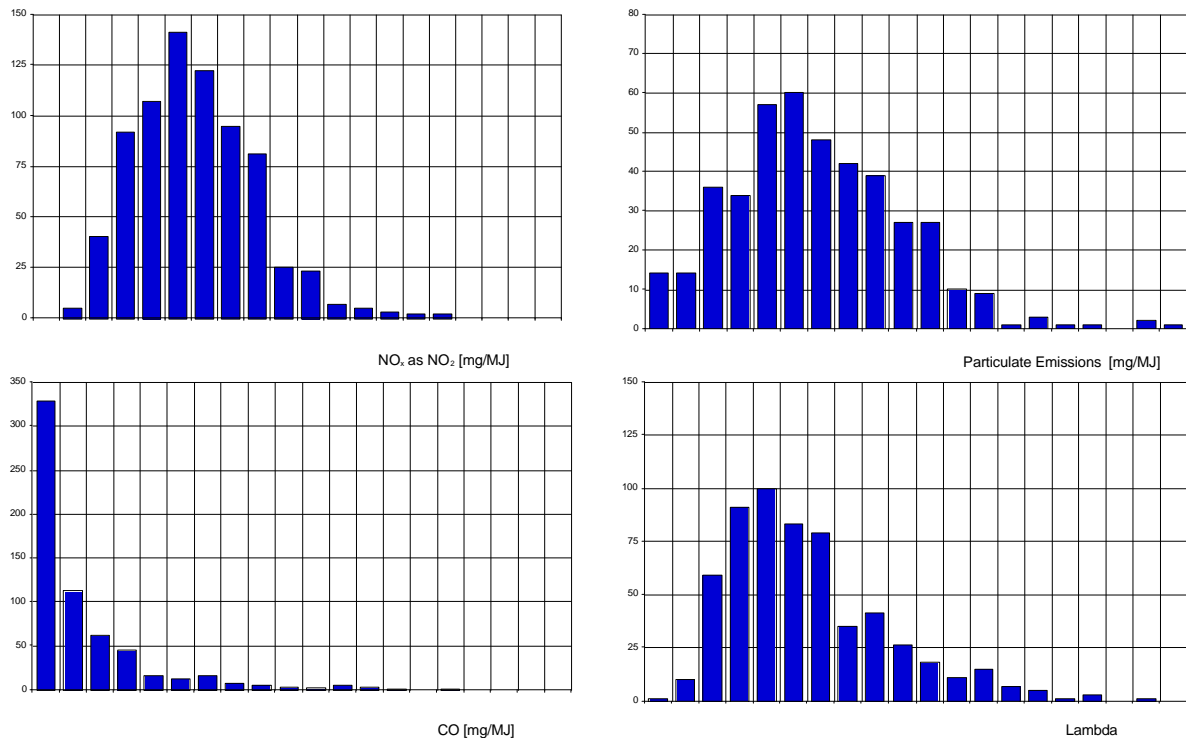

Figure 1: Distribution of NO_x, particulate emissions, and CO in [mg/MJ end energy], and excess air ratio λ for 250 investigated automatic wood furnaces in field measurements [20].

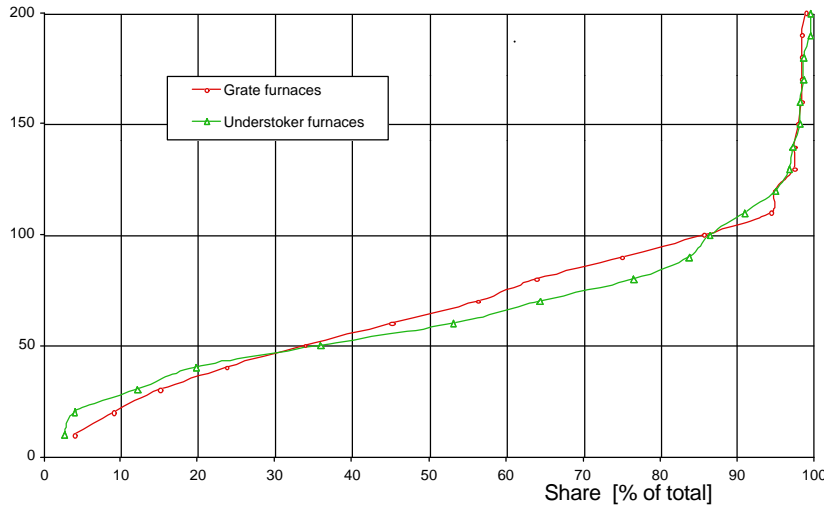

Figure 2: Cumulative distribution of the particulate emissions in [mg/MJ end energy] of grate and understoker furnaces in field measurements [20].

Furthermore, a significant increase in particulate emissions can be found for certain types of wood residues. The distribution of the particulate emissions from all investigated furnaces (more than 1000 measurements on more than 250 furnaces) show that 90 % of all automatic wood furnaces have particulate emissions < 110 mg/MJ end energy (< 200 mg/Nm³ at 11% O₂), while 40 % of the grate furnaces and 50 % of the understoker furnaces have particulate emissions < 55 mg/MJ end energy (< 100 mg/Nm³), Figure 2 (conversion factor = 0.54 for u = 0.2 and 0.56 for u = 0.4, [20]).

The influence of fuel type and operation parameters under well defined conditions is currently investigated in an ongoing project [27].

Table 7: Average particulate emission factors of wood furnaces from field measurements in mg per MJ [20]. M = manual furnace, A = automatic furnace. For the collectible energy, an annual efficiency of 75 % is assumed in [20].
¹ cyclone, ² filter.

	Particulates in	[mg/MJ end energy]	[mg/MJ collectible energy]
M	Log wood boilers	34	45
	OPAC cat. a		
	Wood chips	68	90
	OPAC cat. b ¹		
A	Wood residues	70	93
	OPAC cat. c ¹		
	Urban waste wood	1.5	2
	OPAC cat. Altholz ²		

5.3 Deposit formation

Beside environmental effects, aerosols in the flue gas and mineral matter in the fuel can also lead to damages in the combustion plant. The major effects are:

- deposit formation (Figure 4)
- decreased heat transfer and efficiency
- increased maintenance
- corrosion
- ash slagging.

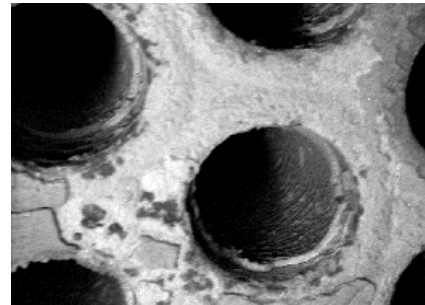

Figure 3: Typical deposit in heat exchanger tubes in a biomass fired boiler [15,21].



Figure 4: Test equipment for pneumatic cleaning of heat exchanger tubes with pressurized air [15,16].

While native wood has a low potential of deposit formation and corrosion, herbaceous biomass can lead to extensive deposit formation on the walls of the combustion chamber and on boiler tubes and following lead to increased corrosion. The aim of an investigation with wood and herbaceous biomass was to identify the mechanisms of deposit formation, to analyse the chemical and morphological properties of the deposits, and to propose measures for deposit reduction [15,19,21]. The deposits from herbaceous biomass were identified as accumulations of fine particles in the nanometer range with KCl as major compound. Fly ash solidifies in flue gas and collects on the cylinder surface due to a decrease in temperature. With respect to the particle shape and size, and the chemical composition of the deposits, thermophoresis was identified as relevant deposition mechanism.

5.4 Primary measures for aerosol reduction

Different developments aim at improved furnace design to reduce particulate emissions by primary measures [22, 23,24]. The different concepts aim at

- complete combustion
- partial particle precipitation in the combustion chamber
- avoid particle entrainment from the fuel bed
- agglomerate particles.

Further, advanced process control devices enable optimized operation under changing load and fuel conditions and can be applied as additional measure for aerosol reduction in automatic furnaces [25,26].

Although certain improvements were achieved, a final solution which allows to reduce particulate emissions safely below 50 mg/Nm³ at 11% O₂ has not been found and implemented in practise yet. Hence, systematic investigations on the influences of primary measures are carried out in an ongoing project [27].

5.5 Secondary measures for aerosol reduction

To avoid deposit formation in the boiler tubes, periodic deposit removal by pressurized air has been developed and tested [15,16,19], Figure 5. In the meantime, this technology is implemented in automatic wood furnaces > 500 kW and available as standard equipment [28].

For particle precipitation in automatic wood furnaces below 2 MW – 5 MW, multi cyclones are applied nowadays. However their separation efficiency for sub-micron particles is close to zero and hence the main fraction of particles under good combustion conditions is not separated. There is a great interest in new separator types which enable significant separation efficiencies for submicron particles but which have far lower investment and operation cost than available fabric filters and electric precipitators. One concepts of interest is the rotational particle separator (RPS) [29,30]. Although it enables higher separation efficiencies than cyclones, the results are by far not competitive with filters.

Another technology for improved particle precipitation is flue gas condensation. Flue gas condensation was implemented as particle separation technique in certain countries a few years ago. However the results achieved in

a demonstration plant in Switzerland were not sufficient to compete with filters [31]. Further, particles found as sludge in the waste water are regarded as disadvantage. To avoid a sludge and to achieve significantly lower particulate emissions, the application of a filter before condensation is recommended.

As a result of ash separation on the grate and particle precipitation from the flue gas, significant amounts of ash are accumulated in biomass combustion. Hence the possibility of ash utilization or disposal is important for the environmental and economic situation of such plants and has been investigated in different projects [32,33].

6. CONCLUSIONS

The air quality situation in Switzerland shows a relevant need of aerosol reduction in the atmosphere of at least 50 %. Hence there is a strong demand to reduce fine particles and precursors of aerosols from all major sources. The main sources are traffic, industry, and households. Among heating facilities in households, wood furnaces contribute with approximately 90 % to the aerosol freight, while they contribute with less than 10 % to household heating. The life cycle assessment of wood combustion shows, that PM 10 emissions contribute with more than one third to the environmental impact of wood furnaces. To improve the environmental assessment of biomass combustion, a reduction of fine particles and NO_x is of high priority. Hence there is a strong demand to reduce aerosol emissions from wood combustion. The same is true for all other biomass used as energy source, since native wood exhibits lower particulate emissions than herbaceous biomass like straw, miscanthus, etc. or also than contaminated wood.

Investigations on aerosols from biomass combustion have shown, that typically more than 80 % of all particles are smaller than 1 µm. The mean particle size is typically around 0.1 µm (between 50 nm to 200 nm). Different investigations have shown, that particle mass, number, and size can be influenced by the furnace type, the fuel type, and the operation conditions. A relevant influence is found by the excess air. Hence optimum design and operation of biomass combustion plants may show a certain potential to reduce aerosol emissions by primary measures.

However, it is assumed, that the reduction potential of primary measures will remain limited and will not enable a dramatic reduction of aerosol emissions (i.e. by a factor of 10 or more). Hence, secondary measures will become more and more important. Among them, fabric filters are regarded as a favourable technology for the reduction of fine particle and of other pollutants such as chlorinated compounds in the flue gas. One of the challenge for future development is to provide filter technologies for the specific needs of biomass combustion at reasonable cost.

ACKNOWLEDGMENTS

Different projects on aerosols from biomass combustion are funded by the Swiss Federal Office of Energy and the Swiss Federal Office of Environment, Landscape, and Forestry, which is gratefully acknowledged.

REFERENCES

- [1] Ordinance on Air Pollution Control (OAPC): *Luftreinhalte-Verordnung (LRV) vom 16. Dezember 1985, Stand am 12. Oktober 1999*, Der Schweizerische Bundesrat, Bern 1999
- [2] BUWAL: *Umwelt in der Schweiz 1997*, Bern 1997 and www.admin.ch/buwal, Bern 2001
- [3] Jansen U.: Bedeutung der Partikel- und Stickoxid-Emissionen aus Holzfeuerungen und Massnahmen zur Luftreinhaltung. 6. *Holzenergie-Symposium*, 20.10.00, ETH Zürich, Bundesamt für Energie, Bern 2000, 69 – 90
- [4] BUWAL: *Schwebstaub, Messung und gesundheitliche Bewertung*. Schriftenreihe Umwelt 270, Bern 1996
- [5] BUWAL: *Modellierung der PM10-Belastung in der Schweiz*. Schriftenreihe Umwelt Nr. 310, Bern 1999
- [6] BUWAL, B. Jordi: Feinstaub in der Atemluft schleicht sich heimlich ins Blut, *Umwelt*, Nr. 2 2000, Bern 2000, 12–14
- [7] BUWAL: *Vom Menschen verursachte Luftschadstoff-Emissionen in der Schweiz von 1900 bis 2010*, Schriftenreihe Umwelt Nr. 256, Luft, Bern 1995
- [8] BUWAL: *Luftschadstoff-Emissionen des Strassenverkehrs 1950 – 2010*, Schriftenreihe Umwelt Nr. 255, Luft, Bern 1995
- [9] BUWAL, Kessler F. and Frischknecht R.: *Heizenergie aus Heizöl, Erdgas oder Holz*, Schriftenreihe Umwelt Nr. 315, Bern 2000
- [10] Baltensperger U.: *Chemische und morphologische Charakterisierung von partikelförmigen Luftfremdstoffen*, Diss Universität Zürich 1985
- [11] Nussbaumer T.: *Schadstoffbildung bei der Verbrennung von Holz*. PhD thesis ETH No 8838. Zurich 1989
- [12] Hüglin C.: *New Applications of Aerosol Photoemission: Characterisation of Wood Combustion Particles and Time Resolved Thermal Desorption Studies*, PhD ETH 11975, Zürich 1996
- [13] Hüglin C., Gaegauf C., Kuenzel S. and Burtscher H.: Characterization of Wood Combustion Particles. Morphology, Mobility and Photoelectric Activity, *Environmental Science and Technology*, 31, p. 3439-3447 (1997)
- [14] Hasler P. and Nussbaumer T.: Particle Size Distribution of the Fly Ash from Biomass Combustion. *Biomass for Energy and Industry. 10th European Conference and Technology Exhibition*, June 8 – 11 1998, Würzburg, Germany, 1330 – 1333
- [15] Kaufmann, H.: *Chlorine compounds in emissions and residues from the combustion of herbaceous biomass*. PhD thesis ETH No 12429, Zürich 1997
- [16] Kaufmann, H. and Nussbaumer, T.: Bildung und Eigenschaften von Chlorverbindungen bei der Verbrennung biogener Brennstoffe. *Gefahrstoffe – Reinhaltung der Luft*, 59 (1999) 7/8 267 – 272
- [17] Mohr M. and Schmatloch V.: Charakterisierung der Partikelemissionen aus Stückholzfeuerungen mit modernen Messtechniken. 5. *Holzenergie-Symposium 16.10.98*, ETH Zürich, ENET, Bundesamt für Energie, Bern 1998, 75–84
- [18] Ch. Gaegauf: Partikelemissionen verschiedener Holzfeuerungen. 6. *Holzenergie-Symposium*, 20.10.00, ETH Zürich, Bundesamt für Energie, Bern 2000, 69 – 90
- [19] Biollaz S. and Nussbaumer T.: Einsatz von Rostfeuerungen für Holz und Halmgüter. 4. *Holzenergie-Symposium*, 18.10.96, ETH Zürich, ENET, Bundesamt für Energie, Bern 1996, 9 – 41
- [20] Hasler P., Nussbaumer T. and Jenni A.: *Stickoxid- und Partikelemissionen von automatischen Holzfeuerungen*, Bundesamt für Energie, Bern 2000
- [21] Kaufmann H., Nussbaumer T., Baxter L. and Yang N.: Deposit formation on a single cylinder during combustion of herbaceous biomass. *Fuel*, 79 (2000), 141 – 151
- [22] Gaegauf C. and Wieser U.: Biomass Burner with Low Emissions of Particulates, *Biomass for Energy and Industry. 10th European Conference and Technology Exhibition*, June 8 – 11 1998, Würzburg, Germany
- [23] Wagner D. and Hasler P.: Kleinschnitzelfeuerung mit optimiertem Verbrennungskonzept und Kompaktwärmetauscher. 4. *Holzenergie-Symposium*, 16.10.00, Bundesamt für Energie, 2000, 103–122
- [24] Wehinger F. and Köb S.: Pyrot: Automatische Holzfeuerung mit Rotationsgebläse. 4. *Holzenergie-Symposium*, 16.10.00, Bundesamt für Energie, 2000, 123–138
- [25] Good J. and Nussbaumer T.: Efficiency Improvement and Emission Reduction by Advanced Combustion Control Technique (ACCT) with CO/Lambda Control and Setpoint Optimization. *Biomass for Energy and Industry. 10th European Conference and Technology Exhibition*, June 8 – 11 1998, Würzburg, Germany, 1362 – 1365
- [26] Leiser O.: Einsatz der CO/Lambda-Regelung an automatischen Holzfeuerungen mit Abgasrezirkulation, 5. *Holzenergie-Symposium*, 16. Oktober 1998, ETH Zürich, Bundesamt für Energie, Bern 1998, 139–156
- [27] Oser M., Nussbaumer T., Schweizer B., Mohr M. and Figi R.: Untersuchung der Einflüsse auf die Partikelemissionen in einer Unterschubfeuerung, 6. *Holzenergie-Symposium*, 20.10.00, ETH Zürich, Bundesamt für Energie, Bern 2000, 51–68
- [28] Schaffner H. and Schmid R.: Massnahmen zur Wirkungsgradverbesserung bei automatischen Holzfeuerungsanlagen, 5. *Holzenergie-Symposium*, 16. Oktober 1998, ETH Zürich, Bundesamt für Energie, Bern 1998, 85 – 102
- [29] Hasler P., Nussbaumer T., Schaffner H. and Brouwers J.: Reduction of Aerosol Particles in Flue Gases from Biomass Combustion with a Rotational Particle Separator RPS. *Biomass for Energy and Industry. 10th European Conference and Technology Exhibition*, June 8 – 11 1998, Würzburg, Germany, 1353 – 1355
- [30] Oser M. and Nussbaumer T.: *Partikelabscheidung bei Holzfeuerungen mit Rotating Particle Separator RPS*, Bundesamt für Energie, Bern 1999
- [31] Neuenschwander P., Good J. and Nussbaumer T.: *Grundlagen der Abgaskondensation bei Holzfeuerungen*, Bundesamt für Energie, Bern 1998
- [32] Noger D., Felber H., Pletscher E. and Hasler P.: *Verwertung und Beseitigung von Holzaschen*, Schriftenreihe Umwelt Nr. 269, Bundesamt für Umwelt, Wald und Landschaft, Bern 1996
- [33] Hasler P. and Nussbaumer T.: *Landwirtschaftliche Verwertung von Aschen aus der Verbrennung von Gras, Chinaschilf, Hanf, Stroh und Holz*, Bundesamt für Energie, Bern 1996

HEALTH EFFECTS OF AEROSOLS: WHAT IS THE EPIDEMIOLOGIC EVIDENCE ?

Charlotte Braun-Fahrländer

Institute of Social and Preventive Medicine, University of Basel, Steinengraben 49
CH-4051 Basel, Switzerland, ++41 61 267 65 08, ++41 61 267 61 90, C.Braun@unibas.ch

1. INTRODUCTION

The epidemiological link between air pollution and death was established many years ago by a series of smog episodes (Meuse Valley, Belgium, 1930; Donora, Pennsylvania, 1948; London, United Kingdom, 1952). In all of these episodes, stagnant weather conditions made concentrations of smoke, sulfur oxides, and other noxious substances rise to levels that were extremely high compared with current conditions in the developed world. In the London episode, the number of extra deaths was estimated to exceed 4000. Although the biological mechanisms involved were poorly understood, there remained little disagreement that, at very high levels, ambient air pollution can be an important risk factor for cardiopulmonary disease and early mortality and effective abatement measures were taken to reduce air pollution levels. During the following decades, there was a general, but unformalized, consensus that levels of outdoor air pollution had been reached in developed countries that were not likely to affect mortality.

Since the mid 1970, however, much additional research on the health effects of air pollution has been conducted. Over the past 10 – 15 years air pollution measurements in many European countries and the US have vastly improved. Ease of access to electronically archived data on mortality and hospital admissions along with an impressive development in analytical tools for statistical evaluation have given researchers new opportunities to explore the relationships between pollution and various diagnostic outcomes for both illness and cause of death. A vast literature has emerged on health effects of atmospheric aerosols. The latter represent a complex mixture of particles directly emitted into the atmosphere and particles that are formed during gas - to - particle conversion processes.

Nearly all of the currently available epidemiology studies of air pollution fall within two broad classifications of study design: Short-term and long-term exposure studies. Short-term exposure studies are typically time-series studies and use temporal changes as their source of exposure variability. These studies evaluate short-term changes in health endpoints associated with short-term changes in pollution. Short-term effects of many gaseous pollutants like ozone, nitrogen dioxide, and sulfur dioxide on respiratory health have often been studied in controlled exposure settings. Although this experimental

methodology has some advantages over epidemiological studies in assessing acute exposures to pollutants, the complexity of real-world exposures to particulate matter limits the utility of this investigatory tool. Thus, most of recent reports of associations between PM exposure and health have been based on observational epidemiology studies.

Long-term exposure studies primarily use spatial differences in pollution as their source of exposure variability. These studies, therefore, compare various health outcomes across communities or neighborhoods with different levels of pollution being principally cross-sectional in design and using longer-term pollution data, usually a year or more. These studies are often interpreted as evaluating the long-term or cumulative effects or exposure.

2. SHORT-TERM EFFECT STUDIES

2.1 Respiratory effects

Numerous time-series studies have observed associations between particulate air pollution and various human health endpoints, including: mortality, hospitalization for respiratory and heart disease, aggravation of asthma, incidence and duration of respiratory symptoms, and lung function.

The fundamental strength of the currently available epidemiological evidence is its ability to evaluate health outcomes with real people who are living in uncontrolled environments and who are exposed to typical pollution. Because individual studies necessarily have methodological restrictions, judgements concerning the validity of these studies must involve evaluating the body of research as a whole. Several recent reviews^{1-3 4 5} have concluded that the consistency of the findings from many differing study designs, data sets, and analytic techniques make it unlikely that the overall particulate matter effects observed could be due to systematic methodological or analytic bias. In addition, the coherence of the effects, the fact that consistent effects are observed among related health end points such as respiratory symptoms, lung function, exacerbation of asthma, hospital admissions and mortality is a strong argument for a causal relation of particulate air pollution and health.

2.2 Cardiovascular effects

Studies that have examined cause-specific mortality have consistently shown that in addition to respiratory deaths, cardiovascular deaths are increased with increased particle exposure⁶⁻⁹. Poloniecki et al. estimated that 1 in 50 heart attacks presenting at London hospitals being triggered by outdoor air pollution.

Postulated systemic effects of increases in particulate air pollution include increased blood coagulability¹⁰, as evidenced by increases in blood viscosity¹¹. The mechanisms by which air pollution leads to cardiac morbidity and mortality, however, remains unknown. Recent research has focussed on cardiovascular endpoints such as heart rate, heart rate variability or blood oxygen saturation. Studies on patient populations, and to a more limited extent in random population samples indicate that low heart rate variability and a high resting heart rate are important risk factors for subsequent cardiovascular events¹²⁻¹⁴. Heart rate variability reflects the autonomic modulation of the rhythmic activity of the sinus node of the heart. Recent animal data support the concept that the autonomic nervous system may be a target for the adverse effects of air pollution¹⁵.

In a study on a panel of 90 elderly subjects, blood oxygen saturation and pulse rate were measured during the winter of 1995-1996 in Utah Valley. Associations of blood oxygen saturation and pulse rate with respirable particulate pollution [PM10]) were evaluated. No effect on blood oxygenation was found, but increased exposure to airborne particulate matter slightly increased heart rate¹⁶. Repeated ambulatory electrocardiographic monitoring was conducted in another study by Pope on 7 individuals with various types of longstanding cardiovascular diseases before, during and after episodes of elevated particle pollution. The investigators found clear relations between elevated PM10 levels and adverse alterations in heart rate variability¹⁷.

The relation between PM2.5 and ozone exposure in a repeated measures study of heart rate variability in 21 elderly active Boston residents including 25 minutes of continuous Holter ECG monitoring per week was investigated by Gold and coworkers. They found significantly less heart rate variability associated with elevated PM(2.5). During slow breathing, ozone and PM(2.5) were both independently associated in a multiple pollution model with a reduction in heart rate variability¹⁸. **Table 1** summarizes the cardiovascular effects of short-term PM exposures.

3. LONG TERM EFFECT STUDIES

Long term effects of particulate air pollution may include effects of low or moderate exposure that persists for a long time as well as the cumulative effects of repeated exposure to elevated levels of pollution. Long term exposure studies typically compare populations living in different geographic areas with varying long term

exposures to air pollution. In these cross-sectional studies information on individual persons is collected and exposure to air pollution is measured using long term averages from existing fixed site monitors. The effect of air pollution on different health endpoints are estimated after adjustment for individual differences in age, sex, smoking, occupational exposures etc.

Over the past decade several cross-sectional studies have been conducted looking at morbidity health endpoints such as lung function or respiratory symptoms in relation to long term exposure to air pollution.

Studies evaluating air pollution effects on lung function include analyses of the first and second National Health and Nutrition Examination Surveys in the U. S. (NHANES I and NHANES II)^{19,20} the SAPALDIA study in adults in Switzerland²¹ and analysis of children's lung function from the 24 U.S. cities²². All of these studies observed small negative associations between lung function and particulate air pollution. A 10 $\mu\text{g}/\text{m}^3$ positive difference in PM10 was typically associated with a two to three percent decline in lung function. Lung function measures have been shown to be important measures of health with remarkable predictive capacity for survival²³. A 2 to 3% shift in population average lung function increases the number of subjects in the lower tail of the distribution thus increasing the number of subjects with clinically relevant reductions in lung function²⁴. In addition, a reduction in lung function with long term exposure to air pollution may indicate one of the important biological mechanisms accounting for the observed association between air pollution and morbidity and mortality.

Other studies have evaluated associations between particulate air pollution and chronic respiratory symptoms and disease^{25, 26 27}, including our own studies in Swiss school children²⁸ (**Figure 1**) and adults²⁹. In all of these studies, statistically significant associations were observed between particulate air pollution and respiratory symptoms most consistently with bronchitis symptoms.

The most compelling evidence of long term effects of air pollution on health was provided by the recent three U. S. cohort studies³⁰⁻³². All of them enrolled several thousand subjects with extensive information about individual characteristics such as age, weight, smoking history, occupational exposure etc. living in selected communities and prospectively collected individual mortality data including survival times and cause of death. Exposure to air pollution was estimated based on measurements from the existing community based monitoring stations. A consistent association between mortality and long term exposure to fine particles was observed. Even after careful controlling for smoking in the analyses the association with air pollution persisted. The results are summarized in **table 2**. Obviously, these cohort studies are costly and time consuming but they provide the most reliable evidence of a link between long term exposure to air pollution and health effects.

4. DIFFERENT SIZE FRACTION OF PARTICULATES

It is well known that the distribution and deposition of particles in the lung varies substantially with particle size. Coarse particles (particles with an aerodynamic diameter between 2.5 and 10 micrometer) have a higher probability of being deposited in the upper airways. Fine particles (with an aerodynamic diameter of 2.5 micrometers or less) are more likely to be deposited in the periphery of the lung, especially in the respiratory bronchioles and alveoli, where their clearance is slow relative to particles deposited in larger airways. The ability of epidemiological studies to differentiate the effects of different size fractions of PM largely depends on the availability of routine measurements of the different PM fractions. In the U. S. simultaneous measurements of PM₁₀ and PM_{2.5} have been performed during recent years. In a time series analysis of daily mortality and different size fractions of PM, Schwartz et. al. showed that daily mortality was more strongly associated with fine particles than with the coarse fraction³³. A similar result was observed in the above mentioned cohort studies. In both, the Six Cities Study and the American Cancer Study mortality was more strongly associated with fine particles and sulfates, respectively, than with PM₁₀ or total suspended particles (TSP).

Another particle size fraction suspected to cause adverse effects on the respiratory and on the cardiovascular system are ultrafine particles. Animal studies have shown that ultrafine particles are able to provoke alveolar inflammation with release of mediators such as cytokines. The epidemiological evidence of health effects of ultrafine particles is limited, mostly because measurements of particle counts as a measure of exposure in population studies are scarce and not routinely available. Secondly, if the different particle size fractions are highly correlated in time or space their respective effects on health are difficult to disentangle. However, in a first study conducted in Germany the association between fine and ultrafine particles and respiratory health was studied in adults with a history of asthma living in Erfurt, Eastern Germany³⁴. Twenty-seven nonsmoking asthmatics recorded their peak expiratory flow (PEF) and respiratory symptoms daily. The size distribution of ambient particles in the range of 0.01 to 2.5 micrometer was determined with an aerosol spectrometer. Most of the particles (73%) were in the ultrafine fraction (smaller than 0.1 micrometer in diameter), whereas most of the mass (82%) was attributable to particles in the size range of 0.1 to 0.5 micrometer. Because these two fractions did not have similar time courses (correlation coefficient $r = 0.51$), a comparison of their health effects was possible. Both fractions were associated with a decrease of Peak expiratory flow (PEF) and an increase in cough and feeling ill during the day. Health effects of the 5-day mean of the number of ultrafine particles were larger than

those of the mass of the fine particles. In addition, the effects of the number of the ultrafine particles on PEF were stronger than those of particulate matter smaller than 10 micrometer (PM₁₀). Most recently, as part of the ongoing European ULTRA study, the same research group reported an association between an increase in the concentration of fine (PM_{2.5}) and the number of ultrafine particles with diary records of feeling bad or very bad in coronary heart disease patients³⁵. In addition, severe angina pectoris symptoms were also elevated in association with fine and ultrafine particles. However, the Finnish ULTRA study team could not confirm these results in a similar panel of coronary heart disease patients in Helsinki^{36 37}.

Particle size is an important determinant of the site and efficiency of pulmonary deposition, but particle size is also a surrogate for particle source and composition. PM_{2.5-10} consists mainly of crustal particles mechanically generated from agriculture, mining, construction, road traffic and related sources, as well as particles of biologic origin. PM_{2.5} consists mainly of combustion particles from motor vehicles and the burning of coal, and wood, but also contains some crustal particles from finely pulverized road dust and soils. A recent study used the elemental composition of size-fractionated particles to identify several distinct source-related fractions of fine particles to examine the association of these fractions with daily mortality in each of six U.S. cities³⁸. Silicon, lead and selenium were used as tracer elements for crustal, mobile, and coal combustion factors, respectively. A 10 $\mu\text{g}/\text{m}^3$ increase in the two day mean of PM_{2.5} was associated with a 1.6% increase in daily mortality. A similar increase in PM_{2.5} from mobile sources accounted for a 3.4% increase in daily mortality and the equivalent increase in fine particles from coal combustion sources accounted for a 1.1% increase. PM_{2.5} from crustal particles were not associated with daily mortality. These results indicate that combustion particles in the fine fraction from mobile and coal combustion sources, but not fine crustal particles are associated with increased mortality. The results are displayed in **figure 2** (adapted from³⁸).

5. LIMITATIONS OF EPIDEMIOLOGIC STUDIES

5.1 Exposure assessment

There are some inherent limitations of epidemiological studies. One relates to the fact, that exposures to air pollution are typically estimated using ambient air pollution data because for studies of large populations personal exposure monitoring is impractical. It had been suggested, that particulate matter concentrations from fixed sites used in time series studies correlate poorly with personal exposures³⁹. However, a recent study by Janssen et al.⁴⁰, repeatedly measuring personal, indoor

and ambient PM₁₀ of non-smoking adults living in Amsterdam demonstrated a reasonably high correlation between personal and outdoor PM₁₀ within individuals over time ($r = 0.5$ to 0.7), providing support for the use of ambient PM₁₀ concentrations as a measure of exposure in epidemiological studies linking the day-to-day variation in PM air pollution to the day-to-day variation in health endpoints.

In studies evaluating long term effects of PM on health, exposure is usually assigned to a group of study subjects living in the same community based on monitoring data from one or several fixed monitoring sites in each community. The causal association of the observed health effects to the measured ambient air pollutant, however, is only plausible if first, the measurements of a single fixed site monitor is representative for the average urban ambient exposure and, secondly, if ambient levels are associated with indoor and personal exposures to outdoor air pollutants. To evaluate the representativeness of a single city monitor for the population mean PM exposure we recently assessed the spatial variability of different size fractions of PM within the city of Basel, Switzerland⁴¹. In general, the spatial variability of fine particles, PM₁₀ and TSP within this urban environment was very small. Mean PM₁₀ concentration at six sites with different traffic density was in a range of less than ± 10 percent of the mean urban PM₁₀ level. This remarkable spatial homogeneity of long term mean PM levels clearly reduces the error of assigning data from one fixed monitoring site to all study subjects living in Basel, as done in recent cross-sectional studies like SAPALDIA.

To evaluate the contribution of outdoor sources to indoor PM_{2.5} concentration, the elemental composition of PM_{2.5} filters, sampled in the framework of the European EXPOLIS-EAS study (Swiss Center Basel) was analyzed⁴². Four tracer elements were considered: sulfur as an indicator for secondary, long-range particles, lead for traffic related particulate matter, and calcium as an indicator for ubiquitous particles from both indoor and outdoor sources. Including all participants the home outdoor PM_{2.5} and home indoor PM_{2.5} mass concentrations were only moderately correlated. If the sample was reduced to non-smoking households (smoking being the most relevant source of indoor PM_{2.5}) the correlation coefficient between indoor and outdoor PM_{2.5} concentrations increased to 0.7. For the outdoor related elements sulfur and lead the indoor/outdoor correlations were high ($r = 0.92$ and 0.93 respectively) whereas the correlation for the ubiquitously present calcium was low ($r = 0.4$). Based on these results it may be concluded, that ambient PM_{2.5} components like sulfur and lead penetrate well from outdoors to indoors. Thus, for PM_{2.5} compounds with a homogeneous spatial distribution and high indoor/outdoor correlation like sulfur, the error in using data from fixed site monitoring stations to predict indoor concentrations is likely to be small.

To further investigate whether personal exposures to fine particles relate to ambient fine particle levels measured home outdoors and at the fixed monitoring site we analyzed the 48-hour personal PM_{2.5} measurements and the respective tracer elements of the Basel sample of the European EXPOLIS-EAS study⁴³. 48-hour personal exposure to PM_{2.5} mass was not correlated to corresponding home outdoor levels. However, in the group of those subjects neither reporting relevant indoor sources nor activities, personal exposures and home outdoor levels of sulfur were highly correlated. It can therefore be concluded, that for long range particle air pollution fixed site fine particle levels are valid exposure surrogates.

An inherent feature of epidemiological studies is the fact, that the various measures of PM used as exposure matrix have to be interpreted as surrogate variables or indicators of the complex mixture of urban aerosols and not necessarily as the toxic substance per se.

5.2 Confounding

In modeling the relationship between health endpoints and variations in particulate air pollution exposure, factors other than air pollution have to be taken into account if they are potential confounders, e. g. both causally related to the health endpoint and associated with temporal changes in exposure. Examples of potential confounders of short term variations in air pollution exposure are meteorological factors such as temperature, humidity, barometric pressure, infectious disease epidemics, and season. The recent epidemiology evaluation project funded by the Health Effects Institute exploring the sensitivity to key modeling assumption of previously published time-series analyses of daily mortality and PM exposure concluded, that the results persisted and were robust to choices of analytic methods⁵. The potential of confounding by other co-pollutants that are correlated with particulate air pollution remains an important limitation of epidemiological studies. One approach is to include the co-pollutants into the regression models and to analytically control for confounding. But it is often impossible to separate the effect of several pollutants if the correlation among them is high. A more compelling approach is to compare the estimated PM effects in areas with different potential for confounding by co-pollutants. Analyses of this type have been conducted that provide little or no evidence of confounding by ozone or SO₂⁴⁴.

Despite of the limitations of epidemiological studies, recent research in the field of aerosols and health yielded consistent and valid results. For policy makers epidemiological studies are of great importance because they assess health effects in populations under real ambient conditions.

Table 1:
Recent studies of cardiovascular effects associated with short term PM exposure

Author / Year	Study population	Result
Poliecki, 1997	Hospital admissions for circulatory diseases in London	Increase in acute myocardial infarction associated with an increase in black smoke, NO, CO, and SO ₂
Pope, 1999	Panel-study in 90 elderly subjects. Blood oxygen saturation and pulse rate measurements	Increase in pulse rate with increasing PM ₁₀ , no effect on oxygen saturation
Gold, 2000	Repeated ECG monitoring in 21 elderly in Boston	Reduction in heart rate variability associated with PM _{2.5} and O ₃

Figure 1

SCARPOL: Prevalence rate of nocturnal dry cough in children plotted against the annual mean of PM₁₀ in each community

Braun-Fahrländer et al. Am J Respir Crit Care Med 1997

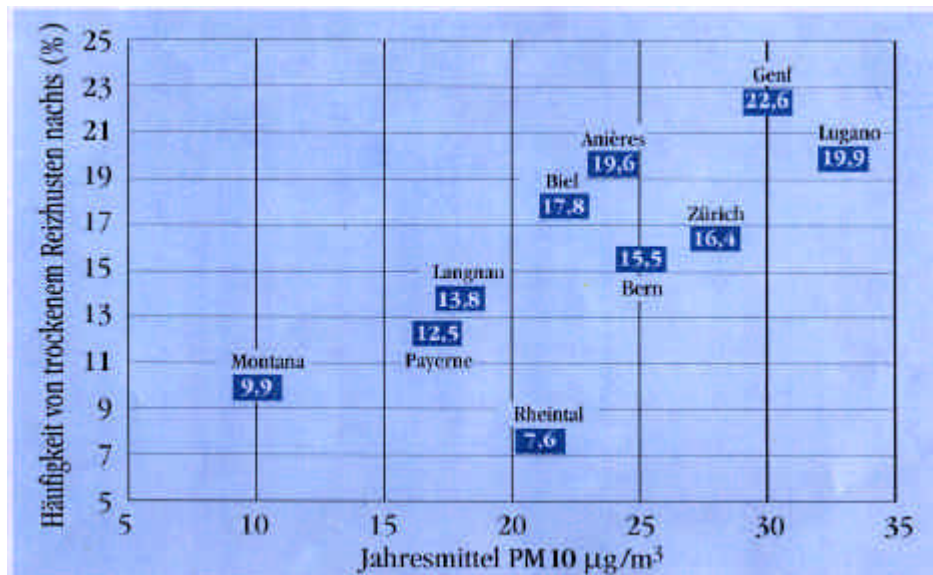

Table 2

Results from the 6-Cities and the American Cancer Society Prospective Cohort Studies

Dockery 1993, Pope 1995

Cause of Death	Particulate Air Pollution (Most vs. Least-Polluted City)		
	6-Cities (PM _{2.5})	ACS (PM _{2.5})	ACS (SO ₄)
All	1.26 (1.08-1.47)	1.17 (1.09-1.26)	1.15 (1.09-1.22)
Cardio-pulmonary	1.37 (1.11-1.68)	1.31 (1.17-1.46)	1.26 (1.16-1.37)
Lung Cancer	1.37 (0.81-2.31)	1.03 (0.80-1.33)	1.36 (1.11-1.66)
All others	1.01 (0.79-1.30)	1.07 (0.92-1.24)	1.01 (0.92-1.11)

Figure 2

Percent Change (and 95th CI) in Daily Death per 10 $\mu\text{g}/\text{m}^3$ PM_{2.5} mass an source specific elements

1979-1988, Harvard Six Cities;

Laden et al, Env Health Perspect 2000; 108 (10): 941-947

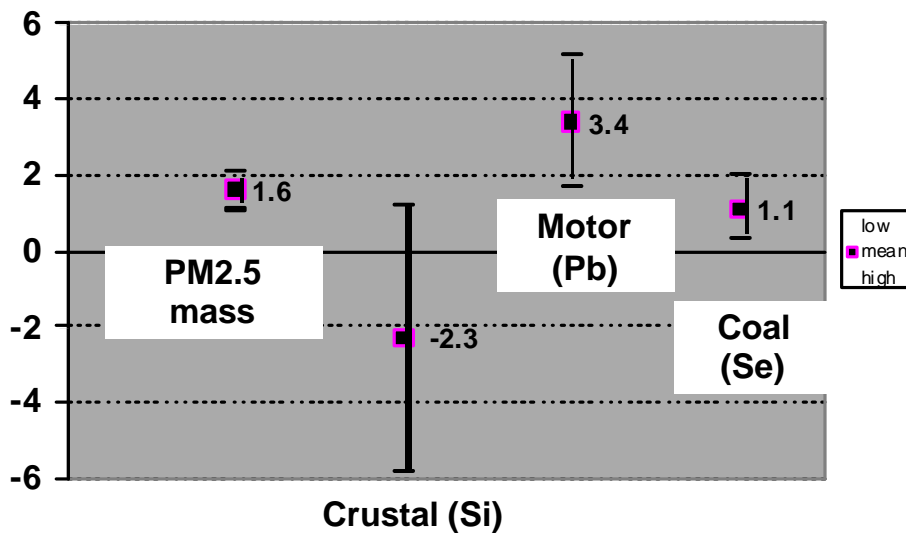

REFERENCES

1. Dockery, D.W. & Pope, C.A., 3rd. Acute respiratory effects of particulate air pollution. *Annu Rev Public Health* **15**, 107-32 (1994).
2. Schwartz, J. Air pollution and daily mortality: a review and meta analysis. *Environ Res* **64**, 36-52 (1994).
3. Ostro, B., Lipsett, M. & Das, R. Particulate matter and asthma: a quantitative assessment of the current evidence. *Appl Occup Environ Hyg* **13/6**, 453-460 (1998).
4. Pope, C.A., 3rd, Bates, D.V. & Raizenne, M.E. Health effects of particulate air pollution: time for reassessment? *Environ Health Perspect* **103**, 472-80 (1995).
5. Samet, J., Zeger, S., Kelsall, J. & Xu, J. Particulate air pollution and mortality: the particle epidemiology evaluation project. *Appl Occup Environ Hyg* **13/6**, 364-369 (1998).
6. Schwartz, J. & Morris, R. Air pollution and hospital admissions for cardiovascular disease in Detroit, Michigan. *Am J Epidemiol* **142**, 23-35 (1995).
7. Schwartz, J. Air pollution and hospital admissions for cardiovascular disease in Tucson [see comments]. *Epidemiology* **8**, 371-7 (1997).
8. Poloniecki, J.D., Atkinson, R.W., de Leon, A.P. & Anderson, H.R. Daily time series for cardiovascular hospital admissions and previous day's air pollution in London, UK. *Occup Environ Med* **54**, 535-40 (1997).
9. Burnett, R.T. *et al.* Associations between ambient particulate sulfate and admissions to Ontario hospitals for cardiac and respiratory diseases. *Am J Epidemiol* **142**, 15-22 (1995).
10. Seaton, A., MacNee, W., Donaldson, K. & Godden, D. Particulate air pollution and acute health effects [see comments]. *Lancet* **345**, 176-8 (1995).
11. Peters, A., Doring, A., Wichmann, H.E. & Koenig, W. Increased plasma viscosity during an air pollution episode: a link to mortality? *Lancet* **349**, 1582-7 (1997).
12. Dekker, J.M. *et al.* Heart rate variability from short electrocardiographic recordings predicts mortality from all causes in middle-aged and elderly men. The Zutphen Study. *Am J Epidemiol* **145**, 899-908 (1997).
13. Gillman, M.W., Kannel, W.B., Belanger, A. & D'Agostino, R.B. Influence of heart rate on mortality among persons with hypertension: the Framingham Study. *Am Heart J* **125**, 1148-54 (1993).
14. Shaper, A.G., Wannamethee, G., Macfarlane, P.W. & Walker, M. Heart rate, ischaemic heart disease, and sudden cardiac death in middle-aged British men. *Br Heart J* **70**, 49-55 (1993).
15. Godleski, J. & Clarke, R. Systemic responses to inhaled ambient particles: Pathophysiologic mechanisms and cardiopulmonary effects. in *Lung biology in health and disease series* (ed. Heyder J, G.P.) 577-601 (Marcel Dekker, 1999).
16. Pope, C.A., 3rd, Dockery, D.W., Kanner, R.E., Villegas, G.M. & Schwartz, J. Oxygen saturation, pulse rate, and particulate air pollution: A daily time-series panel study. *Am J Respir Crit Care Med* **159**, 365-72 (1999).
17. Pope, C.A., 3rd *et al.* Heart rate variability associated with particulate air pollution. *Am Heart J* **138**, 890-9 (1999).
18. Gold, D.R. *et al.* Ambient pollution and heart rate variability. *Circulation* **101**, 1267-73 (2000).
19. Chestnut, L.G., Schwartz, J., Savitz, D.A. & Burchfiel, C.M. Pulmonary function and ambient particulate matter: epidemiological evidence from NHANES I. *Arch Environ Health* **46**, 135-44 (1991).
20. Schwartz, J. Lung function and chronic exposure to air pollution: a cross-sectional analysis of NHANES II. *Environ Res* **50**, 309-21 (1989).
21. Ackermann-Lieblich, U. *et al.* Lung function and long term exposure to air pollutants in Switzerland. Study on Air Pollution and Lung Diseases in Adults (SAPALDIA) Team. *Am J Respir Crit Care Med* **155**, 122-9 (1997).
22. Raizenne, M. *et al.* Health effects of acid aerosols on North American children: pulmonary function. *Environ Health Perspect* **104**, 506-14 (1996).
23. Bates, D.V. *Respiratory function in disease*, (W. B. Saunders, Philadelphia, 1989).
24. Künzli, N. *et al.* Clinically "small" effects of air pollution on FVC have a large public health impact. Swiss Study on Air Pollution and Lung Disease in Adults (SAPALDIA) - team. *Eur Respir J* **15**, 131-6 (2000).
25. Dockery, D.W. *et al.* Effects of inhalable particles on respiratory health of children. *Am Rev Respir Dis* **139**, 587-94 (1989).
26. Schwartz, J. Particulate air pollution and chronic respiratory disease. *Environ Res* **62**, 7-13 (1993).
27. Dockery, D.W. *et al.* Health effects of acid aerosols on North American children: respiratory symptoms. *Environ Health Perspect* **104**, 500-5 (1996).
28. Braun-Fahrländer, C. *et al.* Respiratory health and long-term exposure to air pollutants in Swiss schoolchildren. SCARPOL Team. Swiss Study on Childhood Allergy and Respiratory Symptoms with Respect to Air Pollution, Climate and Pollen. *Am J Respir Crit Care Med* **155**, 1042-9 (1997).
29. Zemp, E. *et al.* Long-term ambient air pollution and respiratory symptoms in adults (SAPALDIA study). The SAPALDIA Team. *Am J Respir Crit Care Med* **159**, 1257-66 (1999).
30. Abbey, D.E., Mills, P.K., Petersen, F.F. & Beeson, W.L. Long-term ambient concentrations of total suspended particulates and oxidants as related to incidence of chronic disease in California Seventh-Day Adventists. *Environ Health Perspect* **94**, 43-50 (1991).
31. Dockery, D.W. *et al.* An association between air pollution and mortality in six U.S. cities. *N Engl J Med* **329**, 1753-9 (1993).
32. Pope, C.A., 3rd *et al.* Particulate air pollution as a predictor of mortality in a prospective study of U.S. adults. *Am J Respir Crit Care Med* **151**, 669-74 (1995).
33. Schwartz, J., Dockery, D.W. & Neas, L.M. Is daily mortality associated specifically with fine particles? *J Air Waste Manag Assoc* **46**, 927-39 (1996).
34. Peters, A., Wichmann, H.E., Tuch, T., Heinrich, J. & Heyder, J. Respiratory effects are associated with the number of ultrafine particles. *Am J Respir Crit Care Med* **155**, 1376-83 (1997).
35. Peters, A. *et al.* Symptoms increase in association with fine and ultrafine particles in patients with coronary heart disease. *Am J Respir Crit Care Med* **161**, A24 (2000).
36. Timonen, K. *et al.* Daily variation of particulate air pollution and heart rate variability in subjects with

- coronary heart disease. The Finnish ULTRA study. *Am J Respir Crit Care Med* **161**, A24 (2000).
37. Pekkanen, J. *et al.* Daily variation of particulate air pollution and ST-T depressions in subjects with stable coronary heart disease..The finnish ULTRA study. *Am J Respir Crit Care Med* **161**, A24 (2000).
 38. Laden, F., Neas, L.M., Dockery, D.W. & Schwartz, J. Association of fine particulate matter from different sources with daily mortality in six U.S. cities . *Environ Health Perspect* **108**, 941-7 (2000).
 39. Wallace, L. Indoor particles: a review. *J Air Waste Manag Assoc* **46**, 98-126 (1996).
 40. Janssen, N.A. *et al.* Personal sampling of particles in adults: relation among personal, indoor, and outdoor air concentrations. *Am J Epidemiol* **147**, 537-47 (1998).
 41. Röösl, M. *et al.* Spatial variability of different fractions of particulate matter within an urban environment and between urban and rural sites. *J Air Waste Manage. Assoc* **50**, 1115-24 (2000).
 42. Mathys, P. *et al.* Indoor PM2.5 from ambient outdoor sources highly correlates with ambient outdoor PM2.5. *J Air Waste Manage. Assoc* (2000).
 43. Oglesby, L. *et al.* Validity of ambient levels of fine particles as surrogate for personal exposure to outdoor air pollution. Results of the European EXPOLIS-EAS study (Swiss Center Basel). *J Air Waste Manage. Assoc* **50**, 1251-62 (2000).
 44. Pope, C. Combustion-Source Particulate Air Pollution and Human Health: Causal Association or Confounding? in *Particulate Matter: Health and Regulatory Issues* (Air and Waste Management Association, Pittsburgh, PA, 1995).

SAMPLING, MEASUREMENT, AND CHARACTERIZATION OF COMBUSTION AEROSOLS FOR CHEMISTRY, MORPHOLOGY, AND SIZE DISTRIBUTION

H. Burtscher

Fachhochschule Aargau, University of Applied Science, Klosterzelgstrasse, CH – 5210 Windisch, Switzerland
phone +41 (0)56 462 42 40, fax +41 (0)56 462 42 45, email h.burtscher@fh-aargau.ch

ABSTRACT: The size of combustion particles ranges from a few nanometers to some ten micrometers. No method for particle analysis can cover the whole size range. Always several methods, based on different physical principals have to be applied. When measuring combustion aerosols, sampling, dilution and pretreatment play an important role. These steps may significantly alter particle properties by processes like coagulation, diffusion- losses, nucleation or condensation. Adequate design of the sampling system is of crucial importance to obtain reliable results. An important part is the treatment of volatile species, included in the exhaust. Depending on the temperature where dilution occurs these species may remain in the gas phase, condense on existing particles, or form new particles by nucleation. The frequently used dilution tunnels do not allow to independently adjust temperature and dilution ratio. Other systems as ejector- and rotating disk dilutor offer more flexibility. Volatile material can be removed by a thermodesorber, which also allows to characterize volatile species by 'thermograms'.

A basic measurement is the determination of the particle size distribution. For ultrafine particles this is most frequently done by differential mobility analysis, often implemented as Scanning Mobility Particle Sizer (SMPS). A recently introduced technique is the electrical diffusion battery, which allows a transient measurement of size distributions in the time scale of seconds, however, with much less resolution compared to mobility analysis. The Electrical Low Pressure Impactor (ELPI) is based on aerodynamic precipitation and yields the aerodynamic diameter, depending on geometry and density.

Carbonaceous particles are an important fraction of ultrafine particles. Methods to characterize these are often based on optical absorption, which is dominated by the carbon fraction. Methods or devices to measure optical absorption are opacimetry, Aethalometer, photoacoustic spectroscopy, laser induced incandescence or photoelectric charging.

Keywords: aerosol characterization, particle sampling, dilution, size analysis

1. INTRODUCTION

Important physical properties of aerosol particles are: size, number, mass, density, surface area, and morphology. Chemical analysis can focus on elementary analysis or analysis of chemical compounds. The analysis can be done for all particles, one size class, a single particle or include the investigation of the chemical microstructure of a particle (e.g. what in at the surface, what belongs to the bulk).

In principal, there are two classes of methods to investigate aerosol particles: Methods based on the analysis of filter samples and in situ methods. The first class allows to apply a large variety of analysis methods, developed for other fields (for example gravimetric analysis, microscopy, chemical spectroscopy). However, filter sampling always includes possible sampling artifacts and does not allow a good time resolution and on line analysis. In situ analysis, on the other hand, requires techniques developed for aerosol characterization, but often allows fast real time measurements. Here mainly the second class will be discussed.

2. BASIC PHYSICAL PROCESSES

Most in situ methods for particle analysis are based either on the interaction of particles with the surrounding gas, mainly by collisions between particles and gas molecules, and interaction with light.

2.1 Inter action of particles with the surrounding gas

The stationary motion of a particle is determined by Stokes law [1]

$$\vec{F} = 6\pi\eta d_b \vec{v} \quad (1)$$

Where F is the force, η the viscosity, d_b the diameter and v the particle velocity. The ratio v/F is called mobility b . Stokes law is valid for particles much larger than the mean free path λ_g in the gas. For smaller particles an empirical correction factor, the Stokes-Cunningham correction

$$C_c = 1 + 1.257K_n + 0.4K_n \exp(-1.1K_n^{-1}) \quad (2)$$

is used. K_n is the Knudsen number $2 \lambda_g/d$.

The mobility can be measured relatively easily by measuring the motion of charged particles under the influence of an electrical field ('mobility analysis'). By measuring the mobility b , the mobility equivalent diameter d_b can be determined. For nonspherical particles this is the diameter of a sphere, having the same mobility as the particle investigated. The mobility is related to the diffusion coefficient by the Einstein relation

$$D = b \cdot kT \quad (3)$$

This means that measuring diffusion yields the same particle property as mobility analysis. D is obtained by determining the particle precipitation due to the thermal motion in devices, called 'diffusion battery'.

Accelerated particle motion is described by

$$\vec{F} = \frac{\vec{v}}{b} + m \frac{d\vec{v}}{dt} \quad (4)$$

The solution of this equation yields a time constant $\tau = mb$. This is a relaxation time constant, giving the time the particle needs to adapt to the new gas velocity. If the gas velocity is v , a distance $v\tau$ is required for this adaptation. If an obstacle is in the gas flow, the ratio of $v\tau$ to the characteristic dimension d of the obstacle decides, whether the particle will follow the gas flow or hit the obstacle ('impaction', see fig 1).

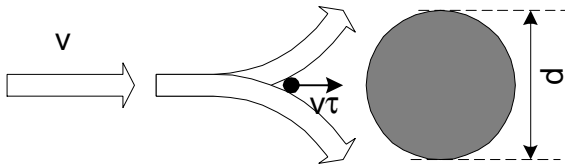

Figure 1: Particle motion in an accelerated (deflected) gas flow

This ratio is called Stokes number s .

$$s = \frac{mbv}{d} \quad (5)$$

which is determined by aerodynamic analysis methods as impaction. From s or τ the aerodynamic diameter d_{ae} is derived, which is the diameter of a unit density sphere, having the same τ . d_{ae} therefore depends on particle geometry (via b) and mass.

The diffusion coefficient D increases with decreasing particle size, diffusion is important or dominant for small particles. Diffusion analysis therefore is an adequate method for very small particles (<300nm). Mobility analysis too is mainly used for small particles. Impaction processes, on the other hand, gain importance with increasing particle size. Impactors therefore are more likely to be used for larger particles. To analyze also small particle by impaction the gas pressure has to be reduced.

Precipitation in filters or in the human respiratory tract also is dominated by diffusion for very small particles, by impaction for larger ones. In the first case the mobility diameter, in the second the aerodynamic diameter is

relevant. These considerations are important when choosing an analysis method.

2.2 Interaction with electromagnetic radiation

An important class of instruments is based on the interaction of particles and electromagnetic radiation, usually light. For this interaction the ratio of particle diameter and wavelength λ is of importance:

- I $d \gg \lambda$: geometrical optics
- II $d \cong \lambda$: Mie theory
- III $d \ll \lambda$: Raleigh theory

Measured properties are light scattering, absorption, and extinction. Mainly the scattering intensity is used to derive the particle size. This yields an optical equivalent diameter, depending on geometry and optical properties (complex index of refraction). For visible light and small particle ranges II and III usually apply. For very small particles (range III) the intensity of scattered light decays with d^6 , absorption with d^3 . For more information see for example [1].

3. SAMPLING AND DILUTION

Errors may occur when sampling is not isokinetic, i.e. when the gas velocity of the main stream and the sampling flow do not match. This is of great importance for large particles ($\gg 1\mu\text{m}$), but usually has only a small influence for submicron particles. The Stokes number is the relevant parameter to calculate errors due to non isokinetic sampling. [1].

For several reasons the exhaust gas has to be diluted:

- Adaptation to the sensitivity range of the used instrumentation
- Cooling
- Prevention of condensation of water and other species

A number of techniques are available, including full flow and partial flow dilution tunnels, which are mainly used for car emissions. Other techniques are ejector dilution (fig. 2) and the rotating disk dilution (fig. 3). The ejector dilution has a constant dilution ratio which usually is in the order of ten. To obtain higher dilution several diluters can be cascaded. The dilution ratio of the rotating disk diluter [2] can be varied from 30 – 1000, however, this system can only be applied for submicron particles.

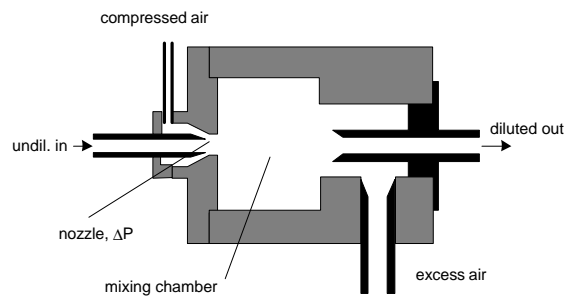

Figure 2: Ejector dilution: The compressed air flow creates a pressure difference ΔP at the nozzle. ΔP controls the inlet flow of the undiluted gas. The dilution ratio equals the ratio of inlet flow and compressed air flow and can be varied by the pressure of the compressed air.

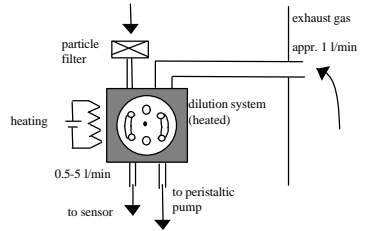
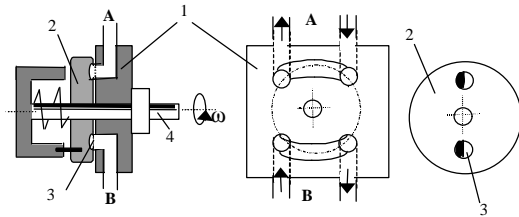

Figure 3: Rotating disk diluter: By cavities 3 in a rotating disk 2 a well defined amount of undiluted gas is transported from the undiluted flow A into a clean gas flow B. The dilution ratio can be varied by varying the speed of rotation.

Often exhaust contains high concentrations of volatile species. These may condense on solid particles or nucleate and form new particles during the cooling and dilution process. This can be prevented by heated dilution. Another possibility is the use of a thermodesorber [3], allowing to remove volatile material (fig. 4). The thermodesorber also allows to study volatile material by measuring 'thermograms' [3].

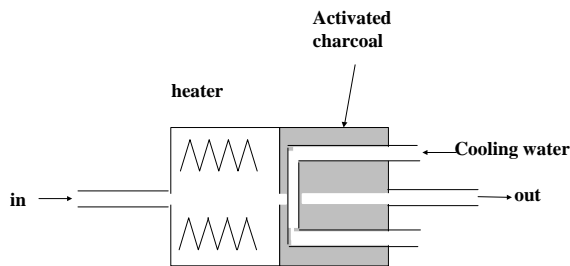

Figure 4: Thermodesorber: volatile material is evaporated in the heated section and adsorbed on the following cooled activated charcoal surface

4. PARTICLE MEASUREMENT

As mentioned in the introduction, this work will focus on in situ methods. Nevertheless, first two important methods based on collected particles will briefly be mentioned. These are gravimetric analysis and microscopy.

4.1 Gravimetric analysis

Gravimetric analysis is the commonly used technique on which present legal limits are based. A filter sample from a well defined amount of exhaust gas is taken. The filter is weighted before and after taking the sample. To avoid errors by water take-up of the filter it is important to always condition it at a certain humidity before weighting. The procedure for the legal measurement including temperatures and dilution is well described. Anything being condensed at the given temperature is measured as particle. If much volatile material is present, slight changes of the temperature may have great influence.

4.2 Microscopy

Transmission electron microscopy (TEM) or scanning electron microscopy (SEM) are very powerful tools to study shape and morphology of particles. Equipped with energy dispersive X-ray (EDX) or electron energy loss (ELL) spectroscopy they also give information on the elemental composition. While TEM allow a higher resolution down to an atomic scale, SEM usually has a better contrast and leaves more freedom to chose the sampling substrate. For TEM very thin grids (often copper) coated with a carbon film are used. The quality of this film is extremely important to obtain a good resolution. If samples are used for quantitative analysis for example of the size distribution, care has to be taken to have a well defined size dependence of the sampling process.

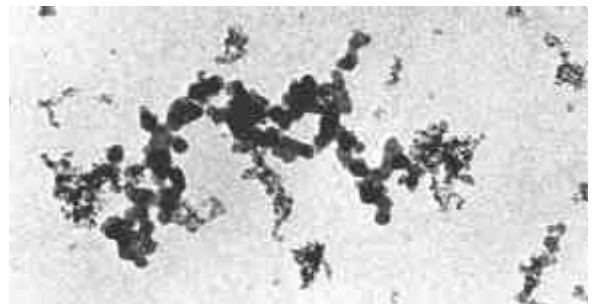

Figure 5: Typical TEM-picture of particles from incomplete combustion (soot), consisting of grape- or chainlike agglomerates of primary particles. The primary particle diameter is about 20nm.

4.3 The Condensation Particle Counter (CPC)

The CPC is the most frequently used device to determine the number concentration. The aerosol flow is first guided through a saturator, where it is saturated with an alcohol vapor (usually butanol). In the following condenser tube the temperature is reduced such that the vapor becomes sufficiently supersaturated to condense on the particles. Thus the particles grow to a size of some μm , which allows to detect them easily by light scattering (see fig. 6). Particles ranging from few nm up to about ten μm can be measured by the CPC.

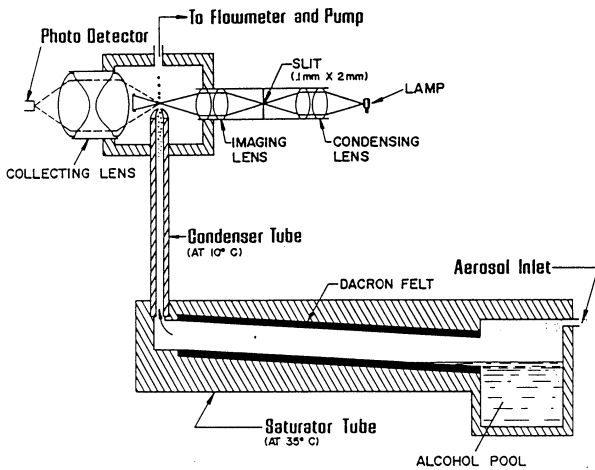

Figure 6: Condensation Particle counter

CPC's have two modes of operation: a counting mode, where pulses of scattered light from individual particles are counted. This mode allows a precise measurement, independently of the parameters of the optical system. However, only one particle is allowed in the detection volume at the same time, which is only possible if the concentration is low. In the second mode (sometimes called opacity-mode), used for high concentrations (typically $>10^4 \text{ cm}^{-3}$), the total scattering intensity is measured and used as a measure for the particle concentration. This requires that all particles grow to the same well defined diameter, and a well calibrated optical system. Generally, this mode is subject to greater errors than the counting mode and requires frequent and careful calibration.

CPC's optimized to measure very small particles allow to detect particles as small as 3 nm. This requires a high supersaturation and low diffusion losses.

4.4 Mobility Analysis

For mobility analysis particles first have to be charged. Differential mobility analyzers almost always use bipolar diffusion charging [1]. This is less efficient than unipolar charging, however, as an equilibrium charge is reached, this method is very well defined and stable. The mobility is then measured by the drift of the particles in an electrical field. In this case the electrical mobility z

$$z = b \cdot q, \tag{6}$$

where q is the particle charge is measured. To calculate the size from z , the charge has to be known, preferably the particles should carry one elemental charge. This can easily be obtained for nanometer particles, but if the size approaches a μm correction for multiple charging becomes necessary.

The setup of the differential mobility analyzer is shown in fig. 7. One size class is selected by the analyzer whose concentration is then determined usually by a CPC.

For correct consideration of multiple charging no particles larger than the measured range must enter, there is a need

for the removal of larger particles which is usually done by an impactor.

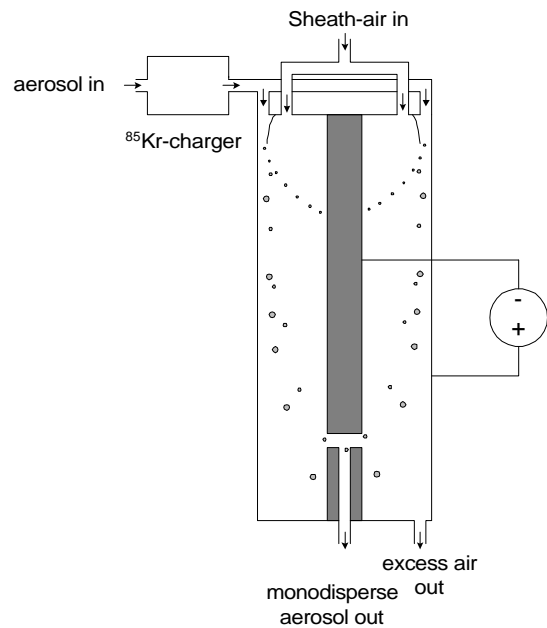

Figure 7: Differential Mobility analyzer (DMA): Charged particles enter the DMA in an outer ring and drift towards the center electrode due to the electrical field applied. One size reaches the slit and is selected.

Two modes of operation are used: In the operation as differential mobility particle sizer (DMPS) the analyzer voltage is increased stepwise to measure a size distribution. This takes about 20 min for a complete run. As scanning mobility particle sizer (SMPS, [4]) the analyzer voltage is scanned in a continuous ramp instead of steps. This reduces the time required to about one minute (depending on concentration and precision required). This significant reduction in time is accompanied by a slightly reduced accuracy. Due to the much faster scan, the SMPS is extensively used. Care has to be taken to choose the correct scanning time. If it is too fast, the size spectrum is distorted. The scanning time can be shortened by reducing the size interval investigated. It is important that during the scan the size distribution is constant. This may be a problem if transient processes occur. Sometimes it is necessary to first sample the aerosol to be analyzed in a bag and then measure by sampling from the bag.

Mobility analysis allows a very good size resolution, one scan covers about two orders of magnitude in size. The size range is some nm to about 700nm. The lower limit is due to diffusion, the upper one to multiple charging of larger particles.

4.5 Diffusion battery

A diffusion battery (DB) classifies particles according to their diffusion coefficient. As diffusion is strong for very small particles, this method is especially useful to analyze particles $< 300\text{nm}$. Diffusion batteries have been used for

a long time. Different types such as parallel plate or screen type DB's are used (fig. 8, [1]).

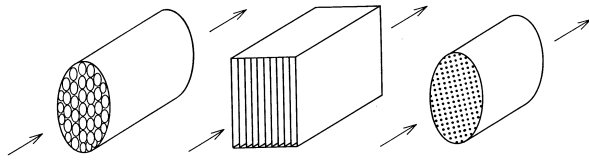

Figure 8: Types of diffusion batteries: Tube package, parallel plate and screen type.

Screen type DB's [5] are most commonly used. Often a CPC is used to determine the input and output concentration. The ratio of input and output concentration gives size information. Usually valves are applied to change the diffusion length (e.g. number of screens). In this case the measurement is stepwise, this means it takes some time.

A new type, the 'Electrical diffusion battery' is introduced in [6]. There the particles are charged prior to entering into the screen type diffusion battery (see fig. 9).

Charged particles, deposited in each stage, can then be measured by measuring the resulting electrical current. A backup filter, following the 4 stages collects all particles which have not been deposited before. This device allows a very simple and fast (seconds) measurement of the size distribution in the size range below about 300nm. Though using an electrical measurement, the sizing occurs by diffusion and therefore is not affected by multiple charging of particles. The pressure drop across the diffusion battery is very small, no problems with evaporation of volatile material occurs.

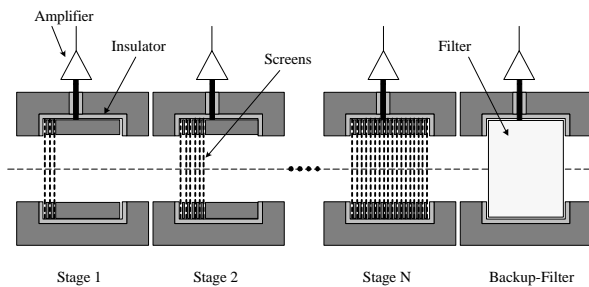

Figure 9: Electrical Diffusion Battery

4.6 Aerodynamic methods

There are mainly two classes of aerodynamic instruments: Impactors, obtaining the acceleration by deflecting the flow and 'aerodynamic particle sizers' [7] using a linear acceleration. Due to the optical particle detection, the lower limit of the second class is at about 0.5 μm. In addition, only low concentrations are possible to avoid coincidence problems. This makes them inadequate for combustion particles. Therefore aerodynamic particle sizers are not considered here.

The basic principle of operation of an impactor is shown in fig.1, the setup of a cascade impactor in fig. 10. Impactors classify according to the aerodynamic diameter.

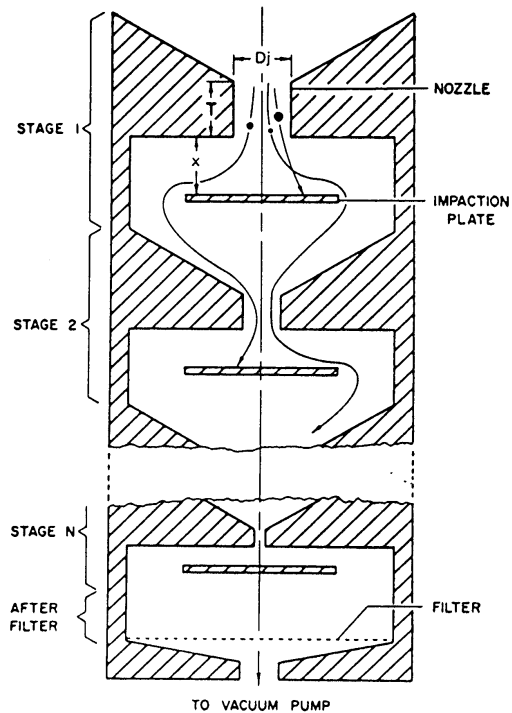

Figure 10: Setup of a cascade impactor. In the first (upper) stage the largest particles are collected, the following stages have nozzles with smaller diameters, leading to higher flow velocity and collection of smaller particles.

Conventional designs can be used down to diameters of some tenth of a micrometer. Low pressure impactors can be used down to nanometer particles. However, the low pressure may lead to evaporation of volatile materials. This problem increases with decreasing lower cut-off diameter (=lower pressure). For example, the lowest stage of the Electrical low pressure impactor (ELPI, see below) with a mean diameter of 30nm is operated at 8 kPa.

Usually cascade impactors with 6 to 12 stages are used [1], which allow a parallel measurement in all size classes. Material, precipitated in the impactor stages is weighted or analyzed chemically. This yields a mass distribution or a size fractionated distribution of a certain species. Often relatively long sampling times are required. A continuous measurement is possible with the Electrical Low Pressure Impactor (ELPI, [8], see Fig. 11). Particles are charged by a corona discharge (unipolar diffusion charging, [1]) prior to entering the impactor. In each impactor stage the current, produced by precipitated particles, is measured. Knowing the charging efficiency, the number concentration can be derived. This allows a real time measurement. The ELPI can be used for transient measurements, the time resolution being in the order of seconds. The sensitivity is high enough for ambient aerosol measurements. The present version has 12 stages. The lowest stage has a cutoff diameter of 32 nm, the highest 10 μm. 32 nm is a very low limit for an impactor, however, for diesel particles it is still not really

sufficient. A new version of the ELPI with a cutoff diameter of 10nm for the last stage is announced.

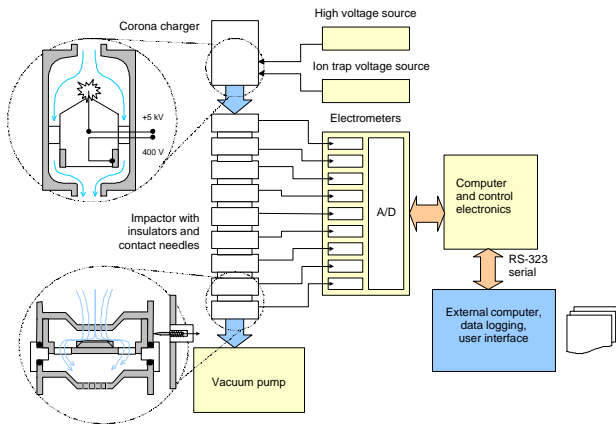

Figure 11: Electrical Low Pressure Impactor (ELPI)

The combination of methods based on mobility and on aerodynamic precipitation allows to obtain the particle mass as function of the diameter, which yields information on the particle structure in terms of a fractal dimension d_f [9].

$$m \propto d^{d_f}$$

$d_f = 3$ means compact, densely packed particles; the smaller d_f , the looser the agglomerates.

4.7 Mass Measurement

An instrument for the direct measurement of the total mass concentration is the tapered element oscillation microbalance (TEOM, see fig. 12).

The change in the resonance frequency of the tapered element, carrying the filter on top, is used to determine the mass of particles, collected in the filter [10]. The TEOM is sensitive enough for ambient air measurements. The time resolution depends on the particle concentration, for diluted exhaust it will be some seconds. According to the manufacturer the detection limit of the instrument is less than $2 \mu\text{g m}^{-3}$ for a 24-hour integrated sample.

Another possibility for mass measurement is the beta gauge method [7]. It depends upon the near exponential decrease in the number of beta particles transmitted through a thin sample as the deposit thickness is increased. The beta particles are emitted as a continuum energy distribution by a radioisotope source (often ^{85}Kr) and a suitable electron counter measures their intensity. The method has the advantages of instrumental simplicity and robustness. The dynamic range of sensitivity is good. A detailed understanding of the parameters which affect the measurements is necessary in order to ensure optimal instrumental implementation and correct interpretation of results. A drawback may be that a radioactive source is required.

4.8 Optical methods

Optical methods have the great advantage that they allow a 'remote' measurement. It is not necessary that the exhaust gas is in touch with the measurement system. Many of the optical methods allow a very fast measurement, which means that they can well be used for transient analysis.

Opacimetry: The extinction of a light beam by scattering and absorption is measured.

Light scattering: Light scattering can be determined by an integral measurement, the instruments used therefore are Nephelometer (wide angle measurement) and photometer (smaller angle). Another way is used in optical particle counters. There the intensity of light, scattered from a single particle is measured. The intensity is used to obtain information on the particle size, the count rate yields the concentration. The scattering intensity depends on diameter and index of refraction (material). Usually optical particle counters are calibrated with Latex-particles. The measurement yields an optical equivalent diameter. In the Raleigh regime (particle \ll wavelength) the scattering intensity scales with d^6 . This leads to a rapid decay when particles get smaller and limits the detectable size to about 100 nm. An integrating measurement of smaller particles is possible if the concentration is high enough. However, again due to the d^6 -relation, an interpretation in terms of mass or number requires a good knowledge of the size distribution. Small

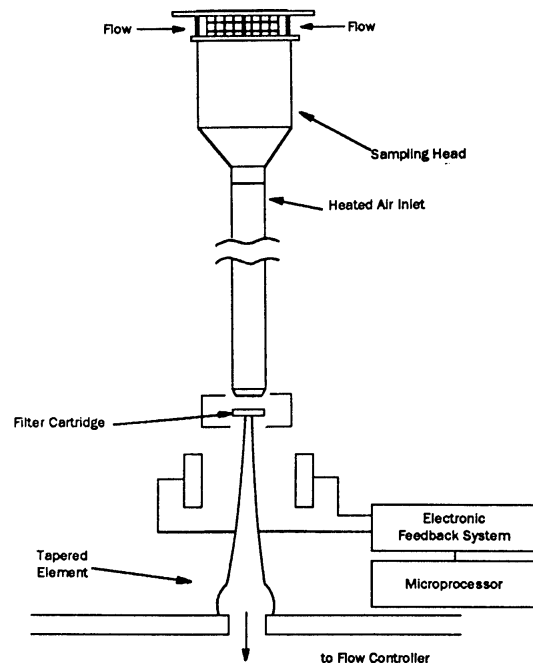

shifts in size have strong effects.

Figure 12: Tapered Element Oscillating Microbalance

Light absorption: Light absorption of exhaust particles is dominated by elemental carbon. Absorption in the Rayleigh regime scales with d^3 . This means that

absorption is related to the particle volume and therefore to the mass. Absorption measurements can be used to determine the carbon mass.

Usually absorption cannot be measured by attenuation of a light beam, because this is dominated or at least strongly influenced by scattering. A number of techniques have been developed for absorption measurements. Some of them are discussed in the following.

Aethalometer: The Aethalometer measures the attenuation of a white light beam through a transparent filter, on which the particles are collected [11]. The chosen configuration allows to minimize the influence of scattering.

Nevertheless, absorption coefficients found vary significantly, depending on the origin of the particles.

Photoacoustic Spectroscopy: In photoacoustic spectroscopy particles are heated by absorption of light from a chopped laser beam [12]. The resulting acoustic wave is then measured. This is a very direct in situ method. So far no commercial instruments are available. A problem are cross sensitivities by absorption of gaseous species (water vapor, NO_x). If these can be overcome, photoacoustic will be a relatively simple, direct, and fast method.

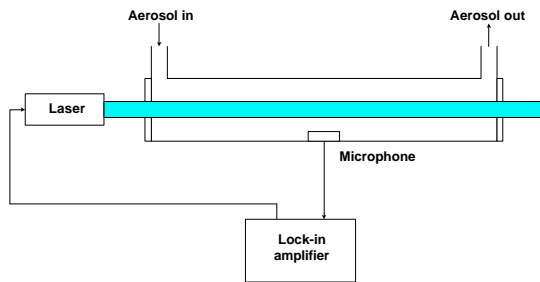
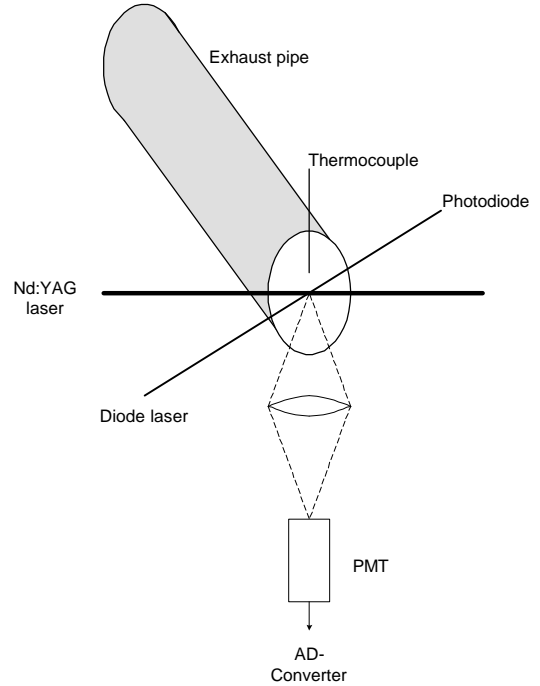

Figure 13: Setup for photoacoustic spectroscopy

Time Resolved Laser induced incandescence (TIRE-LII): In TIRE-LII the radiation of particles, heated by a short (some ns) laser pulse, is measured. The intensity of the radiation can be used to determine the elemental carbon mass, the time dependence of the cooling of the particles yields information on the primary particle size, based on a thermal model of the particle radiation. [13]. LII was introduced as a tool for combustion research and recently has also been used for exhaust gas measurements. The advantages of TIRE-LII are that it is a very fast and sensitive method. It can be applied in the undiluted gas, for example directly at the end of the exhaust pipe (Fig. 11). The system is relatively compact, however, the frequency doubled pulsed laser system (Nd:YAG), the spectral filters required to suppress elastic scattering and reflections, and the nanosecond electronics have their price.

As already mentioned the data evaluation is based on a radiation model, which has to include also volatile material and requires the knowledge of a number of parameters. This may lead to errors. An important input parameter is the gas temperature which is measured by a thermocouple. The mass determination requires

calibration. From mass and primary particle size a number concentration can be calculated under assumption of a particle density and therefore their structure. However, this is the concentration of primary particles, not the concentration of emitted particles, as the particles form agglomerates. The same has to be said for the determined size, which is a kind of volume based diameter of the



primary particles.

Figure 14: Setup for a measurement with TIRE-LII at the end of the tailpipe. The additional laser diode-extinction measurement is used for calibration

The Photoelectric aerosol sensor (PAS): In the photoelectric aerosol sensor, [14] particles are illuminated by ultraviolet light, which leads to emission of electrons (photoelectric effect). The electrons are then quickly removed from the gas by an electric field (ion trap in As photoemission involves absorption of a photon by the particle bulk material and emission of an electron through the particle surface, the resulting charge on the particles depends on surface properties and a material coefficient.

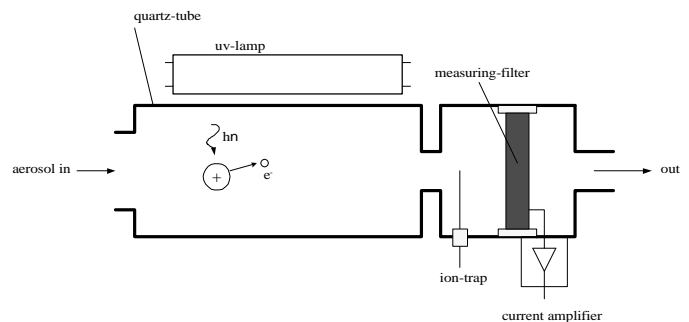

Figure 15: Photoelectric aerosol sensor

This material coefficient is especially large for particles from incomplete combustion. A number of empirical studies show that the emission probability is closely related to the elemental carbon concentration in the case of diesel engines. In former ambient air studies the PAS signal was correlated with total concentration of particle bound polycyclic aromatic hydrocarbons (Hart et al., 1993). The PAS allows a continuous measurement with a time resolution of about 1 s. The detection limit is in the order of 100 ng/m³ and is good enough for ambient air measurements in urban areas.

4.9 Surface measurement

For the interaction with their surrounding the particle surface is of crucial importance.

Both instruments described in the following measure the so called 'active surface', which is based on the integral collision cross section [15].

Epiphaniometer: The Epiphaniometer (EPI) was developed at the Paul Scherrer Institute (PSI, [16]). The EPI is based on the attachment of lead atoms (²¹¹Pb), produced by the radioactive decay of a long-lived ²²⁷Ac source. The number of attached ²¹¹Pb lead atoms is then determined by counting the β-decay events of its daughter, ²¹¹Bi. The Epiphaniometer measures the active surface of particles. It is a very sensitive, but slow instrument, for an integration time of 30 min, the detection limit is 0.003 μm² cm⁻³.

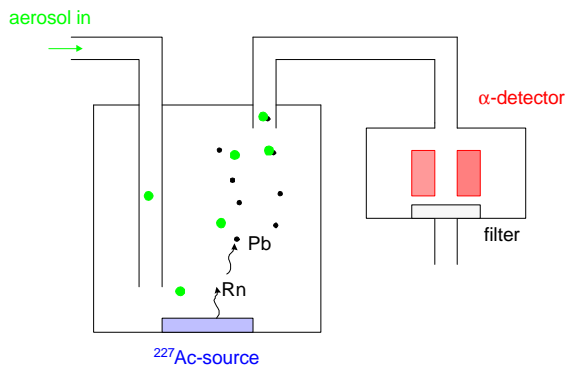

Figure 16: Epiphaniometer

Diffusion Charging Sensor (DC): In the diffusion charging sensor (referred to as DC) positive ions from a corona discharge diffuse onto the particles. The filter current is proportional to the active surface of the particle ensemble.

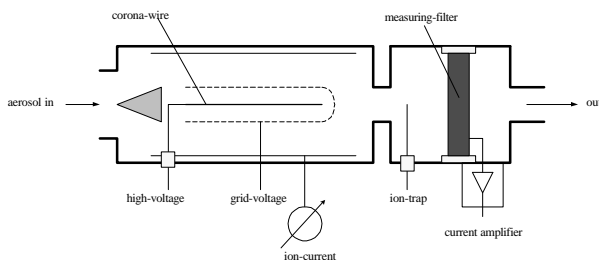

Figure 17: Diffusion Charging Sensor

The DC yields the same information as Epiphaniometer, but is much faster and simpler and, on the other hand, significantly less sensitive. The response time is short enough to allow transient measurements. To avoid artifacts by the repelling Coulomb potential high particle charges have to be avoided, which on the other hand reduces the detection limit. The detection limit of about 1(m²/cm³) is sufficient for emission- and ambient air measurement in urban areas.

5. CONCLUSIONS

Particles are agglomerates of primary particles, typically 20nm in diameter, which have a chain- or grapelike structure. Due to this structure, the volume does not scale with d³. The size of the particles strongly depends on the degree of agglomeration, which is determined by the initial number concentration and the time available for agglomeration. The agglomeration rate scales with the square of the concentration

$$\frac{dN}{dt} = k \cdot N^2 \tag{7}$$

where k is the coagulation coefficient [1]. No direct relation between number concentration and mass exists.

Processes as dilution, coagulation, nucleation, and condensation, which may occur in the sampling lines strongly influence the result of a measurement. A careful design of the sampling lines therefore is of crucial importance to obtain reliable measurements. In particular, temperatures and dilution have to be chosen correctly. This can for example be done such that a 'dry' measurement is done, meaning that all condensable material is removed by a thermodesorber or kept in the gas phase by sufficiently high dilution with preheated dilution air. Another possibility is to try to condense as much as possible to include most of the condensable material in the measurement. So far it is not clear which measurement is of greatest relevance for possible health effects. However, it has to be expected that health effects by solid particles and solvable material have a different mechanisms. These two classes should therefore be treated differently.

Results from different techniques which are based on different physical/chemical particle properties are difficult to relate. In particular, different sizing instruments yield different 'sizes'. The really measured property (mobility, scattering intensity....) is related to an equivalent diameter (mobility diameter, aerodynamic diameter, optical diameter).

No method covers the entire size range, no diameter definition can be used for the entire size range.

Often a volume equivalent diameter is calculated from the measured quantity (often the mobility diameter) by using a dynamic shape factor. As the particle shape is not really known and different for every particle, the shape factor is not known either and based on assumptions.

REFERENCES

[1] Hinds, W.C. *Aerosol Technology*, John Wiley, New York 1998.

- [2] Hüglin, Ch., L. Scherrer, and H. Burtscher: An accurate, continuously adjustable dilution system (1:10 to 1:104) for submicron aerosols. *J. Aerosol Sci.* 28 (1997) 1049-1055.
- [3] Burtscher, H., U. Baltensperger, N. Bukowiecki, C. Hüglin, M. Mohr, U. Matter, S. Nyeki, N. Streit, E. Weingartner: Separation of Volatile and Non-volatile Aerosol Fractions by Thermodesorption: Instrumental Development and Applications. *J. Aerosol Sci.* 32 (2001) 427-442.
- [4] Wang, S.C. and R.C. Flagan: Scanning electrical mobility spectrometer. *Aerosol Sci. Technol.* 13 (1990) 230-240.
- [5] Scheibel, H. G. and J. Porstendörfer: Penetration measurements for tube and screen-type diffusion batteries in the ultrafine particle size range. *J. Aerosol Sci.* 15 (1984) 673-682.
- [6] Burtscher, H., L. Scherrer, and H.C. Siegmann: The electrical diffusion battery for dynamic classification of nanoparticles. *Proc. 4. ETH-Conference on Nanoparticle Measurement*, 2001.
- [7] Willeke, K. and P. A. Baron: *Aerosol Measurement, Principles, Techniques and Applications*. Van Nostrand Reinhold, New York 1993.
- [8] Keskinen, J., K. Pietarinen, M. Lehtimäki: Electrical Low Pressure Impactor. *J. Aerosol Sci.* 23 (1992) 353-360.
- [9] Schleicher, B., S. Künzel and H. Burtscher: In-situ measurement of size and density of submicron aerosol particles. *J. Appl. Phys.*, 78 (1995) 4416-4422.
- [10] Patashnick H. and G. Rupprecht: Advances in microweighing technology. *Am. Laboratory* July (1986) 59-64.
- [11] Hansen, A.D. and T. Novakov: Real-time measurement of aerosol black carbon during the carbonaceous species methods comparison study. *Aerosol Sci. Technol.* 12 (1990) 194-199.
- [12] Petzold, A. and R. Niessner: Photoacoustic soot sensor for in-situ black carbon monitoring. *Appl. Phys. B- Lasers O*, 63 (1996) 191-197.
- [13] Schraml, S, S. Will, A. Leipertz, T. Zens, and N. D'Alonso: Performance Characteristics of TIRE-LII Soot Diagnostics in Exhaust Gases of Diesel Engines. *SAE Technical Paper Series* 2000-01-2002.
- [14] Burtscher, H. and H.C. Siegmann: Monitoring PAH-emissions from combustion processes by photoelectric charging. *Combust. Sci. Technol.* 101 (1994) 327-332.
- [15] Siegmann K. and H.C. Siegmann: Fast and reliable 'in situ' evaluation of particles and their surfaces with special reference to diesel exhaust. *SAE Technical Paper Series* 2000-01-1995.
- [16] Gäggeler, H.W., U. Baltensperger, M. Emmenegger, D.T. Jost, A. Schmidt-Ott, P. Haller and M. Hofmann: The epiphaniometer, a new device for continuous aerosol monitoring. *J. Aerosol Sci.* 20 (1989) 557-564.

AEROSOL FORMATION FROM STRAW COMBUSTION - DANISH EXPERIENCES

H. Livbjerg

Department of Chemical Engineering, Technical University of Denmark
Dk-2800 Kgs. Lyngby

1. INTRODUCTION

In Denmark, biomass combustion is an important element in the governmental efforts to increase the use of renewable energy sources. In the year 2000, biomass - principally straw - accounts for 10% of the total fuel consumption. Emissions from straw combustion was previously poorly investigated and the Danish Department of Energy and the Danish power companies have initiated a number of field and laboratory studies of particle formation and emissions from boilers to acquire a better understanding of the behaviour of straw combustion particles.

A further incentive for these studies is that combustion processes are among the suspected sources of the fine particle size fractions for which specific new ambient air quality standards, the so-called PM_x standards, are now being imposed due to the recognition of human health degradation after long term exposure to elevated levels of these particles. The fine particles are usually defined as particles with an aerodynamic diameter¹ less than either 1 or 2.5 μm . The mass concentration of these particle fractions are denoted PM_1 and $PM_{2.5}$ respectively.

2. STRAW COMBUSTION AEROSOLS

Straw is an inhomogeneous solid fuel with a low volumetric heating value. The straw used for combustion in Denmark are primarily wheat, barley, oats, rye, and oil seed rape. The contents of ash and sulphur in straw are low compared to a typical bituminous coal but the straw is rich in silicon, chlorine and potassium. The potassium and chlorine content is very variable and depends on the crop species, soil properties, fertilization and the amount of precipitation during the harvest season. Combustion particles in general are formed by one of two paths, 1) the solid-to-particle path comprises particles formed by the release of ash inclusions and unburnt fuel to the flue gas without phase change and 2) the solid-vapour- particle path comprises particles formed by recondensation of volatilized ash constituents. The first path yields large particles, often called coarse-mode particles, while the last path typically yields small, submicron particles in a high number concentration, often

called the fine-mode particles. (Flagan and Seinfeld, 1988)

The flue gas from straw combustion contains submicron aerosol particles, SO_2 and HCl in varying but often significant concentrations. They constitute some of the problems caused by the large content of volatile salts in straw. These salts, in particular KCl, vaporize during combustion and cause slagging and corrosion of ducts and cooling surfaces and influence the emission of gaseous and particulate pollutants in the flue gas (Frandsen et al., 1999). The submicron particle concentration before the particle filter varies considerably but often exceeds 1000 mg/m^3 (Christensen et al., 1998) which leads to high particle emissions through the stack due to the high penetration of submicron particles through the electrostatic precipitator (Nielsen et al., 2001) or scrubbers (Johannessen et al., 1997). The submicron particles primarily contain potassium chloride and sulphate.

3. FLUE GAS CHEMISTRY

An important conclusion of several field studies is the evident interaction between the gas pollutants SO_2 and HCl and the particle composition due to chemical reactions between vapour phase species prior to particle formation.

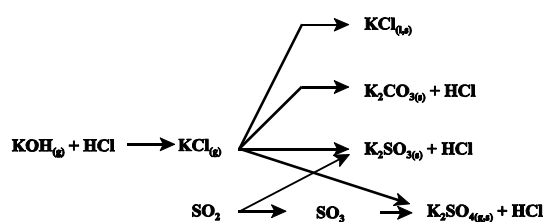

Figure 1. Possible pathways to particles for evaporated potassium species

As the flue gas is cooled, the chemical reactions in figure 1 are shifted from left to right with the important routes being those leading to chloride and sulphate. Figure 2 shows composition profiles during cooling of the flue gas simulated by a theoretical model (Christensen, 1995; Christensen et al., 1996, 1998) While the chemical reactions in figure 1 tend to be equilibrated at high temperatures, some of them, and in particular the oxidation of SO_2 to SO_3 , become kinetically controlled at low temperature. This is seen on figure 2 as a deviation between the concentration of SO_2 and the corresponding equilibrium concentration $SO_2^{(eq)}$ below approximately $800^\circ C$, where the

¹) The aerodynamic diameter is defined as the diameter of a sphere with density 1 g/cm^3 which has the same gravitational sedimentation velocity in air at standard conditions. Environmental regulations of particulate matter PM_x are usually based on the aerodynamic particle diameter.

oxidation of SO_2 actually comes to a halt, which determines the ultimate distribution of the sulphur and chlorine between gas and particle phases. The simulation in figure 2 reveals important details about the mechanism of particle formation: By further cooling, the vapour phase concentration of K_2SO_4 increases rapidly beyond the saturation level and eventually exceeds the nucleation threshold, by which an abundant number of new particle seeds are formed by homogeneous nucleation of sulfate particles. These particles act as condensation nuclei for the subsequent condensation of chloride vapours, which ultimately transfers all potassium from gas to particle phase.

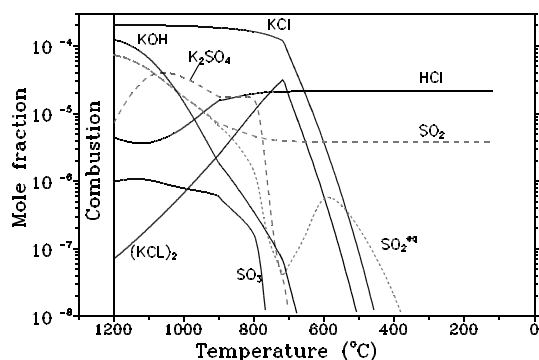
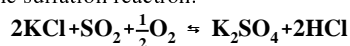

Figure 2. Computed concentration of gas species during cooling of the flue gas.

This proposed mechanism for the formation of the fine mode particle fraction in straw combustion has been corroborated by both model - and laboratory studies (Christensen and Livbjerg, 2000; Jensen et al., 2000).

The composition of the flue gas actually seems to be determined by chemical equilibria at a temperature of approximately 820 °C. Below this temperature only phase transformations occur. The chemical equilibrium condition can expediently be stated as an equilibrium for a single reaction, the sulfation reaction:



The equilibrium constant for this reaction at 820 °C yields a simple algebraic equation which determines the distribution of sulfur and chlorine between gas and particle phases.

$$\frac{[\text{K}_2\text{SO}_4] [\text{HCl}]^2}{[\text{SO}_2] [\text{KCl}]^2} =$$

$$K_{eq} [\text{H}_2\text{O}] [\text{O}_2]^{1/2} = K'_{eq} = 0.25 \pm 0.08$$

This simple model explains observations from many Danish field studies (Christensen et al., 1996, 1998).

One of the remaining obstacles to a complete understanding of straw combustion particles is an uncertainty about the factors influencing the volatilisation of the ash components during combustion.

For a number of studies, Christensen et al. (1998) found that on the average 18 % of potassium is volatilized, the

corresponding fractions for sulfur and chlorine being 43 % and 66 % respectively. Especially for potassium the degree of volatilisation varies considerably. One of the important factors seems to be the content of silicon in the ash, which apparently binds potassium in the bottom ash and prevents its evaporation. Thus the straw of oil seed rape which has a low content of silicon yields a high degree of potassium volatilisation.

New investigations have revealed a surprisingly low degree of potassium volatilisation during coal-straw co-combustion. This seems to be caused by the binding of straw-derived potassium as alumina-silicates in the coal ash particles. (L.B.Nielsen, 1998)

4. REFERENCES:

Christensen, K.A. (1995). *The Formation of Submicron Particles from the Combustion of Straw*. Ph.D.-Thesis, Department of Chemical Engineering, Technical University of Denmark, Lyngby.

Christensen, K.A., Stenholm, M. and Livbjerg, H. (1998): *The Formation of Submicron Aerosol Particles, HCl and SO₂ in Straw-Fired Boilers*, J. Aerosol Sci. **29**(4) 421-444

Christensen K.A. and Hans Livbjerg (2000): *A plug flow model for aerosol nucleation, growth and coagulation in an alkali containing flue gas*. Aerosol Sci. and Techn. **33** (6) 470-489

Christensen K.A. and Hans Livbjerg (1996) : *A Field Study of Submicron Particles from the Combustion of Straw*, Aerosol Science and Technology, **25**, 184-199

Frandsen, F.J., H.P. Nielsen, P.A. Jensen, L.A. Hansen, H. Livbjerg, K. Dam-Johansen, P.F.B. Hansen, K.H. Andersen, H.S. Sørensen, O. Larsen, B. Sander, N. Henriksen, and P. Simonsen (1999): *Deposition and Corrosion in Straw- and Coal-straw Co-Fired Utility Boilers- Danish Experiences*, in Gupta et al (eds.): *Impact of Mineral Impurities in Solid Fuel Combustion*, 271-283, Kluwer Academic/Plenum Publishers.

Johannesen, J.T., J. A. Christensen, O. Simonsen and H. Livbjerg (1997): *The Dynamics of Aerosols in Condensational Scrubbers*. Chem. Eng. Sci. **52** 2541-2556

Jensen, J.R., L. B. Nielsen, C. Schultz-Møller, S. Wedel, and H. Livbjerg (2000): *The nucleation of aerosols in flue gases with a high content of alkali -a laboratory study*, Aerosol Sci. and Techn. **33** (6) 490-509

Nielsen L.B.(1998): *Combustion aerosols from potassium-containing fuels*. Dept. Chem. Eng., Technical Univ. Denmark.

Nielsen, M.T., C. Lange Fogh, J. Nørklit Jensen, C. Lund, K. Poulsen, B. Sander, P. Simonsen and H. Livbjerg (2001): *Formation and emission of fine particles from two coal-fired power plants*. Submitted

Flagan, R.C., Seinfeld, J.H. "Fundamentals of air pollution engineering", Prentice Hall Inc., New Jersey (1988)

MODELLING AND EXPERIMENTAL RESULTS ON AEROSOL FORMATION, DEPOSITION AND EMISSIONS IN FLUIDIZED BED COMBUSTION OF BIOMASS

Jorma K. Jokiniemi*, Terttaliisa Lind, Jouni Hokkinen,
Juha Kurkela and Esko I. Kauppinen

VTT Chemical Technology, Aerosol Technology Group
P.O.Box 1401, 02044 VTT, Finland, *corresponding author

ABSTRACT: In Fluidized Bed (FB) combustion of biomass ultra fine particles are formed by alkali sulphates and chlorides nucleation and condensation on metal oxide seed particles. The supermicron particles are composed of bed material and residues of fuel particles. The composition of submicron and supermicron particles is clearly distinctive as the fine particles are composed mainly of K, Cl, S, Na and Ca and the coarse particles of Ca, Si, K, S, Na, Al, P, Fe. The distribution of these elements between the fine and coarse mode depends much on the fuel composition and combustion conditions. Also toxic trace element species may volatilize into the gas phase. The behaviour of these species in the flue gas is determined by the gas phase chemistry, surface reactions, nucleation and condensation. To control the emissions of fine particles and trace metals it is important to understand their partitioning between gas and particle phases at different temperatures as well as their distribution between different particle size classes. Also the leachability of the condensed phase is important.

We have carried out a number of field measurements in Circulating Fluidized Bed (CFB) and Bubbling Fluidized Bed (BFB) boilers burning biomass, coal and waste to measure size distributions, chemical composition and morphology of particles formed in these processes [1,2,3,4,5]. We have also developed a numerical model (ABC code) to solve simultaneously the dynamics of aerosol particles and volatilized metals[6,7]. Similar studies in other combustion systems have been carried out by e.g [8,9]. In this paper mechanisms of particle formation and dynamics in FB combustion of biomass is presented first and then simulated and measured results for aerosol and lead (Pb) species behaviour in a Bubbling Fluidized Bed (BFB) boiler are compared. Finally particle size distributions before and after a particle separation device (ESP) with two fuel compositions are given.

It can be concluded that the fuel composition is a key parameter affecting deposition, corrosion and emission. Increased chlorine, alkali and trace element concentrations in the fuel will increase both fine particle and trace element emissions, respectively. To model aerosol formation, deposition and emissions is a complicated task involving fluid flow, chemistry and particle dynamics. Our ABC model including simplified flow model, equilibrium chemistry and detailed particle dynamics is able to predict the fine particle composition and size which is in relatively good agreement with measured results for a BFB boiler burning biomass, peat and waste fuels. However more understanding of reaction kinetics is needed before the model can predict the full particle size distribution.

1. INTRODUCTION

Biomass combustion is becoming more and more attractive because the greenhouse gases released during combustion are consumed for their growth and thus the net emission can be considered to be zero. However recently the adverse health effects of fine particles have become an important issue and fine particle emissions from biomass combustion is considered to be one of the major sources. Thus it is important to understand the fine particle formation mechanisms to be able to choose the best available combustion technology for different purposes.

Fine particle formation in a small scale combustion is quite different from large scale processes. Usually in small scale combustion the fuel burning is incomplete and a major fraction of the fine particle mass is composed of organic and inorganic carbon species. The emissions from these processes are also highly time dependent and difficult to predict from a mechanistic point of view. In

contrary large scale combustion of biomass is a fairly stable process with almost complete combustion and thus the fine particles emitted from these processes are composed of mainly inorganic metaloxides, alkalichlorides and sulphates. In this paper the large scale combustion of biomass in fluidized beds is considered.

Fluidised bed combustion has been found to be a suitable process for producing energy from biomass fuels. Behavior of inorganic ash-forming species plays a major role when operational problems such as bed agglomeration, fouling and corrosion of the heat exchangers are considered. The size distribution and the morphology of the fly ash are of interest when ash deposit formation is studied. Coarse ash particles impact on the heat exchanger surfaces with a high probability, but often do not adhere on the surface. Particle retention on the deposit becomes much more favourable if the deposit surface or the surface of the impacting particle is formed of sticky material. Enrichment of alkali sulphates and chlorides has been

observed on superheater deposits. Alkali compounds and their solutions have low melting temperatures, usually close to heat exchanger operating temperatures. Condensing on the pre-existing fly ash particles or on the heat exchanger tubes they form a low viscosity sticky layer that highly contributes to the deposition rates of impacting supermicron particles. Ash originated fine particles have also gained increasing interest in relation to health effects. Once emitted from the stack fine particles are carried along with flue gasses and have a high probability of penetrating into the alveolar regions of lungs. These particles have typically high specific surface area, they can be enriched of toxic species and they penetrate more easily particle separation devices as compared to supermicron particles.

2. AEROSOL DYNAMICS

To be able to understand particle formation in boilers, one needs to know the basics of aerosol dynamics first. Generally 100 μm is considered the maximum size of an aerosol particle. Aerosol dynamics covers such phenomena as homogeneous and heterogeneous reactions of condensable species, homogeneous and heterogeneous condensation of these species to form and grow aerosol particles, agglomeration of particles and deposition of particles and vapour. In the following we briefly describe these phenomena.

2.1 Homogeneous Condensation (nucleation)

In the boundary layer of burning fuel particles metals or their oxides are volatilised due to high temperature and oxygen starvation at the particle surface, which causes reduction of metal oxides to their lower oxide states [10]. These species have higher vapour pressures and are thus volatilised more easily as compared to their oxidised forms. As these vapours diffuse away from the particle surface and the oxygen concentration is increased, these species convert back to their oxidised forms at the same time as the temperature is decreased. As a combination of high cooling rate and conversion to species with low vapour pressure the volatilised metal oxides become highly supersaturated. Saturation ratio of a certain vapour is defined as the ratio of its partial pressure to its equilibrium pressure. If the saturation ratio is larger than one, the vapour is supersaturated. For example, if SiO reacts with oxygen, gaseous SiO₂ is formed. Because of the very low equilibrium vapour pressure of SiO₂(g), this vapour becomes supersaturated immediately after formation. Thermodynamically, supersaturation is not a favoured state, and thus the vapour starts to condense. Condensation decreases the partial vapour pressure toward its equilibrium value. If there are no other particles in boundary layer of a burning fuel particle, when the supersaturation starts to increase, vapour molecules stick together and form new aerosol particles. This process is called homogeneous nucleation and it requires a critical supersaturation, which is much higher than one. When this critical supersaturation level has been reached, tiny

aerosol particles are formed at a rate, which can be predicted with the use of thermodynamics and kinetic considerations. It is also possible that alkali sulphates nucleate as they are formed in the gas phase and have much lower vapor pressure as compared to their hydroxide and chloride precursors.

2.2 Heterogeneous Condensation

If there are other particles, such as metal oxide seeds around, the released alkali and trace element vapours start to condense on the surface of these particles before any new particles can be formed by homogeneous nucleation. This is due to the fact that condensation on surfaces starts at lower supersaturation ratios than homogeneous nucleation. The growth rate of the particles can be solved directly from the heat and mass transfer equations for single particles with the use of numerical methods.

2.3 Agglomeration

Agglomeration is a process where particles collide with each other and stick together. Collision rate is determined by Brownian and turbulent diffusion. When submicron particles collide, they always stick together. Particle size, chemical composition and process conditions determine the properties of these agglomerated particles. If the colliding particles are liquid they form a new spherical liquid droplet and in the other extreme the colliding solid particles stay together by Wan der Vaals attraction. In reality agglomerates formed in combustion processes tend to sinter together and form particles with a complex morphology.

2.4 Non-spherical Particles

In combustion processes the formed particles may deviate from spherical shape. This can be taken into account by two different ways. The most sophisticated way is the concept of fractal like agglomerates [11]. In this case the agglomerated particles are composed of a large number of primary particles of same size. Now the spherical particle radius in condensation and agglomeration equations is replaced by the collision radius defined as:

$$R_c = R_0 n_p^{\frac{1}{D_f}} \quad (1)$$

where R_c is the collision radius, R_0 is the primary particle radius, n_p is the number of primary particles in an agglomerate and D_f is the fractal dimension.

Unfortunately it has been observed that in real combustion processes the primary particle size is not constant and the large non-spherical particles are of various shapes and can not be described easily by the concept of fractal dimension. In this case the most relevant way is to replace the collision radius by a collision shape factor multiplied by the volume equivalent radius:

$$R_c = X_c R_p \quad (2)$$

where X_c collision shape factor and R_p is the volume equivalent radius of the particle. This method has been implemented in the ABC code as the most applicable way to describe the dynamics of non-spherical particles in real combustion systems.

2.5 Modelling Aerosol Dynamics in the ABC Code

In the ABC code we simulate the combustion process using elemental volatilisation rates and possible initial seed particle size distribution as input data. The change in the particle size and chemical composition spectrum is due to the mechanisms of chemical reactions, homogeneous nucleation, vapour condensation, agglomeration and deposition. The whole process is described by the General Dynamic Equation (GDE) [12].

In combustion processes steady-state conditions can be assumed. Thus we solve the aerosol GDE in 1-dimensional stationary form along the flow direction. Mass size distributions of different species can be calculated by solving the condensed phase species GDEs, where the particle size spectrum is divided into a number of grid points:

$$\frac{dm_{jk}}{dx} = \left(\frac{dm_{jk}}{dx} \right)_{gtp} + \left(\frac{dm_{jk}}{dx} \right)_{agg} - \frac{V_{dk} A_d}{u \Delta V} m_{jk} \quad (3)$$

Here m_{jk} is the mass concentration of species j at the k th grid point corresponding to radius r_k , respectively. The first term at the right (gtp) corresponds to particle formation due to homogeneous nucleation and growth by condensation and chemical reactions. The second term (agg) describes agglomeration and the third term the rate of particle removal due to deposition on boundary surfaces. V_{dk} is the particle deposition velocity, A_d is the deposition area and ΔV is the axial volume step. Particle velocity (u) is calculated by taking into account gas velocity, Stokes drag and gravitation. The rate of change in the molar concentration of a gas phase species is given by the gas phase species conservation equation :

$$\frac{dc_j}{dx} = \left(\frac{dc_j}{dx} \right)_{form} - \left(\frac{dc_j}{dx} \right)_{gtp} - \frac{v_d A_d}{u_g \Delta V} c_j \quad (4)$$

where c_j is the gas phase molar concentration of species j . The first term (form) at the right represents the formation rate of these species, which can be calculated from local gas phase chemical equilibrium or from reaction kinetics. The second term (gtp) describes the vapour depletion rate by nucleation, condensation and chemical reactions and the third term represents the depletion rate due to vapour deposition by condensation and chemical reactions on structures. V_d is the vapour deposition velocity and A_d is the deposition area. Here time is related to the axial

position through the gas velocity (u_g). A more detailed description of the ABC model can be found in^{6,7}.

3. RESULTS

The ABC code was utilized for a BFB boiler and the results were compared with field measurement [13] results for two fuels with different composition i.e. fuel #1 and #2. The capacity of the plant was 66 MW_{th} and the process parameters are presented in table 1 and the fuel compositions in table 2. The boiler input geometry and temperatures are given in Figure 1.

3.1 Deposition and aerosol formation

Volatilised amount alkali and lead species as well as initial size distribution for ash, flue gas composition, temperatures and geometry of the boiler were given as input for ABC. Following elements, gas phase chemical species and condensable species were included in the calculation based on chemical equilibrium considerations for the most stable species:

Elements C, K, Na, Cl, S, H, O, N, and Pb;

Gaseous species C, CO₂, CO, Cl, Cl₂, HCl, S, SO₂, SO₃, H₂S, H₂SO₄, H, H₂, OH, H₂O, O, O₂, N₂, K, KOH, KCl, K₂Cl₂, K₂SO₄, Na, NaOH, NaCl, Na₂Cl₂, Na₂SO₄, Pb, PbCl, PbCl₂, PbO, PbH;

Condensable species KOH, KCl, K₂SO₄, K₂CO₃, NaOH, NaCl, Na₂SO₄, Na₂CO₃, Pb, PbO, PbCl₂, PbSO₄

and Inert Ash Particles.

Based on experimental results the initial ash particle size distribution was given as a bi-modal or tri-modal lognormal distribution. The corresponding number median radii (NMR) and geometric standard deviations (GSD) for the ultrafine (u), intermediate (i) and large (l) particle modes were initially given as:

$$\text{NMR}_u = 0.02 \mu\text{m}, \text{GSD}_u = 1.8$$

$$\text{NMR}_i = 0.7 \mu\text{m}, \text{GSD}_i = 1.8$$

$$\text{NMR}_l = 10.0 \mu\text{m}, \text{GSD}_l = 2.4$$

According to the calculations the amount of chlorine has a clear effect on the deposition rates of alkali metal compounds. Measurements indicate that the concentration of fine particles is approximately doubled when firing fuel #2, which is the same result as obtained from ABC calculations. In the case when there is more chloride compounds (mainly KCl) present in in gas phase there is also more condensation on large particles and since deposition efficiencies of supermicron particles are approximately tenfold compared to submicron particles, deposition rates of alkali chlorides are also increased.

Chlorine concentration of the fuel seems to affect also the mass size distributions calculated with ABC. When firing fuel #2 the relative amount of Na₂SO₄ and K₂SO₄ in large particles was increased compared to firing fuel #1. According to the calculations these species were formed

little earlier in the combustion process, which may serve as an explanation for this observation. Impaction is clearly the most important deposition mechanism in all cases.

In the following the calculated mass and species size distributions together with measured size distributions for fuel #2 are presented (figs 4 and 5). In the calculations the gas phase species reactions with large particles was not considered as there is not reliable data to model this effect. The calculated results indicate that condensation on large particles was insignificant. As an uncertainty the effect of particle shape on condensation rate was checked, but it had hardly no effect on condensation rates. Thus we may assume that the species present in large particle mode may not have vaporized completely or that the vaporised species have chemically reacted with large particles. Also the effect of re-entrained particles should be considered here.

The deposition of condensible species is dependent of vapor phase speciation as well as fine and coarse particle mode concentrations. The dependence is complicated and is not analysed in detail here, but one can clearly see that for higher Cl concentration in fuel also the deposition is higher.

3.2 Trace element behaviour

For volatilised trace element behaviour we have chosen lead as an example. To understand the condensation mechanisms we need to consider the gas phase reactions of these species, surface reactions, condensation and agglomeration. At high temperatures the gas phase speciation reactions are rapid and can be treated with the use of chemical equilibrium. However at lower temperatures chemical kinetics may control the speciation of these species. Here we assume that gaseous lead dichloride is formed according to thermodynamic equilibrium. We also varied the surface energy (Kelvin effect for droplets) term, but it did not affect the results. The results are presented in figures 6 and 7.

3.3 ESP Performance with two fuels

Measurements of the particle mass size distributions before and after ESP were performed with two different fuels. The fuels were different from those presented earlier as the base fuels was a mixture of biomass and peat and the high chlorine fuel contained about 10% refuse (REF) waste fuel. The fuel analyses is not available at the moment, but one can see from figs. 8 and 9 that change to high chlorine fuel increases the submicron particle mass before ESP. The ESP penetration is very slightly better for the high chlorine fuel due to higher conductivity of the ash particles. Thus the emission of fine particles is clearly higher for the high chlorine fuel.

4. CONCLUSIONS

The comparison between simulated and measured data for the fine mode agree well and indicate that the fine mode is composed mainly of condensed K, Cl, S and Na. The chlorine present in the large particle mode can not be a result of condensation according to the simulation. This conclusion could be drawn since the only uncertain factor, namely the particle shape, did not affect the results. Thus the chlorine in large particles is most probable a result of chlorine reaction with the large particle species or from the re-entrained particles due to erosion and soot blowing. Also lead species are reactive with aluminosilicates present in bed and fuel particles and thus the observed lead in large particles is a result of reactions and re-entrainment. The amount of chlorine clearly affects the volatilisation alkali and trace elements. As the ESP penetration is about the same for the two fuels in our measured boiler the fine particle and trace element emissions are higher for a high chlorine fuel. Also increased concentrations of alkalis and trace element in the fuel increases their emissions.

In future we will include in the ABC code the reaction rates of volatilized species with particles. Also a large data base for different trace elements as well as the measured particle collection device penetration as a function of particle size will be included to be able to simulate trace element releases into the environment at different conditions and fuel compositions.

ACKNOWLEDGMENTS

This study is funded by the Finnish Technology Development Centre (Tekes), Ahlström Machinery Oy, Fortum Oy, Kvaerner, Foster Wheeler and VTT.

REFERENCES

1. Lind, T. (1999) Ash formation in circulating fluidized bed combustion of coal and solid biomass, PhD Thesis, VTT Publications 378, Espoo, Finland.
2. Latva-Somppi, Jouko (1998) Experimental studies on pulp and paper mill sludge ash behaviour in fluidized bed combustors, PhD Thesis, VTT Publications 336, Espoo, Finland.
3. Joutsensaari, J., Kauppinen, E., Jokiniemi, J., and Helble, J. (1994) Studies on ash vaporization in power plant scale pulverized coal combustion. In: Williamson, J. and Fraser, W. (eds.) The Impact of Ash Deposition on Coal Fired Plant. The Engineering Foundation Conference Proceedings, Solihull, UK 20 - 25 June 1993. pp. 613 - 624.
4. Kauppinen, E., Lind, T., Valmari, T., Ylätaalo, S. and Jokiniemi, J. (1996) The structure of submicron ash from pulverized combustion of South African and Colombian coals. In: Applications of Advanced Technology to Ash-Related Problems in Boilers, Eds. Larry Baxter and Richard DeSollar. Engineering Foundation Conference, Waterville Valley, USA 16 - 21 July 1995. pp. 471 - 484.
5. Valmari, T., Kauppinen, E., Kurkela, J., Jokiniemi, J., Sfiris, G., Revitzer, H. (1998) Fly ash formation and deposition during fluidized bed combustion of willow. *J. Aerosol Sci.* 29. pp. 445 - 459.

6. Jokiniemi, J., Lazaridis, M., Lehtinen, K. and Kauppinen, E. (1994). Numerical Simulation of Vapour-Aerosol Dynamics in Combustion Processes. *J. Aerosol Sci.*, Vol. 25(3). pp. 429 - 446.
7. Jokiniemi, J., Pyykönen, J., Mikkonen, P. and Kauppinen, E. (1995). Modelling Alkali Salt Deposition on Kraft Recovery Boiler Heat Exchangers. Proceedings of the 1995 Int. Chem. Recovery Conference, Toronto, April 24-27, 1995. pp. 77-87.
8. Christensen, K. A. and Livberg, H. (1996). A field study of submicron particles from the combustion of straw. *Aerosol Sci. Tech.*, 25, pp. 189-199.
9. Christensen, K. A. Stenholm, M. and Livberg, H. (1998). The formation of submicron aerosol particles, HCl and SO in straw-fired boilers. *J. Aerosol Sci.*, 29, pp. 421-444.
10. Neville, M. and Sarofim, A. F. (1982). The Stratified Composition of Inorganic Submicron Particles Produced during Coal Combustion. 19th Symp. (Int'l) on Combustion, pp. 1441-1449.
11. Friedlander, S. K. (1977). *Smoke Dust and Haze*. John Wiley & Sons, New York.
12. Lehtinen, K. E. J., Windeler, R. S. and Friedlander, S. K. (1996) Prediction of Nanoparticle Size and the Onset of Dendrite Formation Using the Method of Characteristic Times. *J. Aerosol Sci.*, Vol. 27. pp. 883 - 896.
13. Kurkela, J., Latva-Somppi, J., Tapper, U., Kauppinen, E. I. and Jokiniemi, J. (1998) Ash formation and deposition onto heat exchanger tubes during fluidized bed combustion of wood-based fuels. In Proceedings of International Conference on Ash Behavior Control in Energy Conversion Systems, Yokohama, Japan. pp. 110-118.

Table 1. Selected process parameters for the BFB biomass boiler

<i>Fuel</i>	1# wood residue (75%) forest residue (25%)	2#: wood residue (75 %) chipboard(25%)
Fuel feed rate (dry), [t/d]	210	210
Fuel feed rate (wet), [t/d]	430	430
Load, [MWth]	38	43
O ₂ (wet), [vol %]	4,3	3,9
CO (dry), [vol-ppm]	57	72
SO ₂ (dry), [vol-ppm]	< 5	< 5
NO ₂ (dry), [vol-ppm]	120	160
Temperature, bed [°C]	810-840	830-870
Temperature, loc #2 [°C]	120	124-127
Primary air flow, [Nm ³ /s]	10,7	10,7
Sec. air flow, [Nm ³ /s]	16,5	16,5
<i>Flue gas flow, [Nm³/s]</i>	35.8	35.8
<i>H₂O [vol %]</i>	22	22
<i>CO₂ [vol-%]</i>	12	12
<i>O₂ [vol-%]</i>	5-6	6
<i>HCl, [vol-ppm]</i>	8.92	5.34

Table 2. Fuel analysis results

<i>Fuel</i>	1# wood residue (75%) forest residue (25%)	2#: wood residue (75 %) chipboard (25%)
Moisture [wt %]	51,7	52,3
Ash, dry [wt %]	1,5	1,8
Volatile, dry [wt %]	78	77
Fixed carbon, dry [wt %]	20,1	21,4
C, dry [wt %]	51,5	50,4
H, dry [wt %]	5,9	5,7
N, dry [wt %]	0,24	0,54
S, dry [wt %]	0,05	0,03
O, dry [wt %]	40,8	41,5
Cl, dry [wt %]	0,017	0,029
Na, dry [wt %]	0,033	0,046
K, dry [wt %]	0,104	0,101

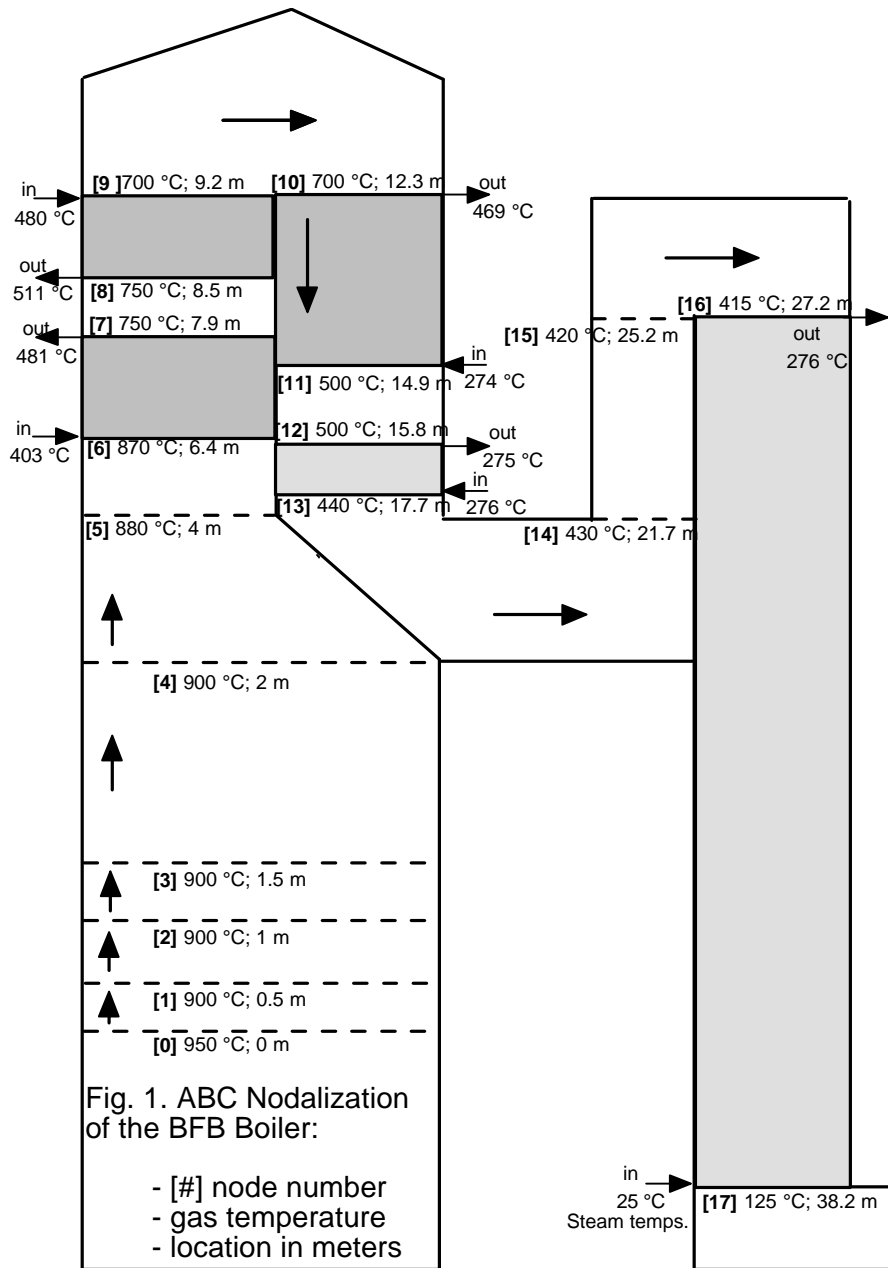

Fig. 1. Geometry, flow directions and temperatures of the modelled BFB boiler.

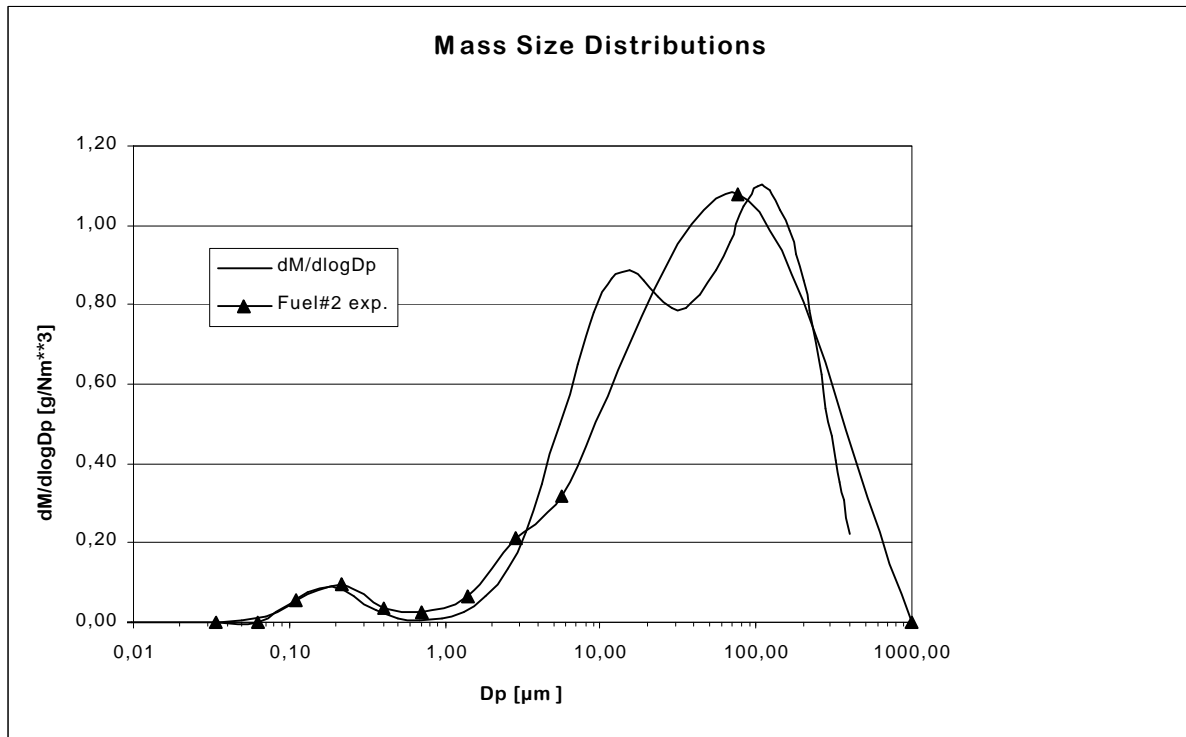

Fig. 2. Comparison between simulated and measured particle size distributions before the ESP.

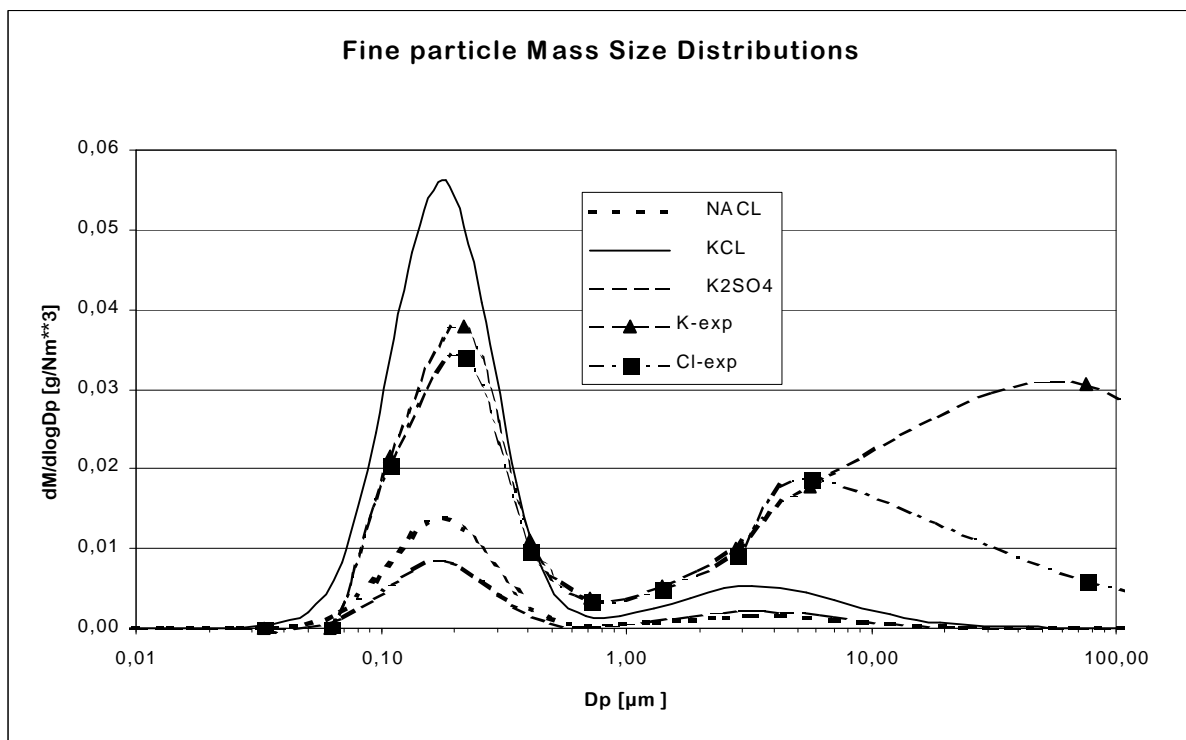
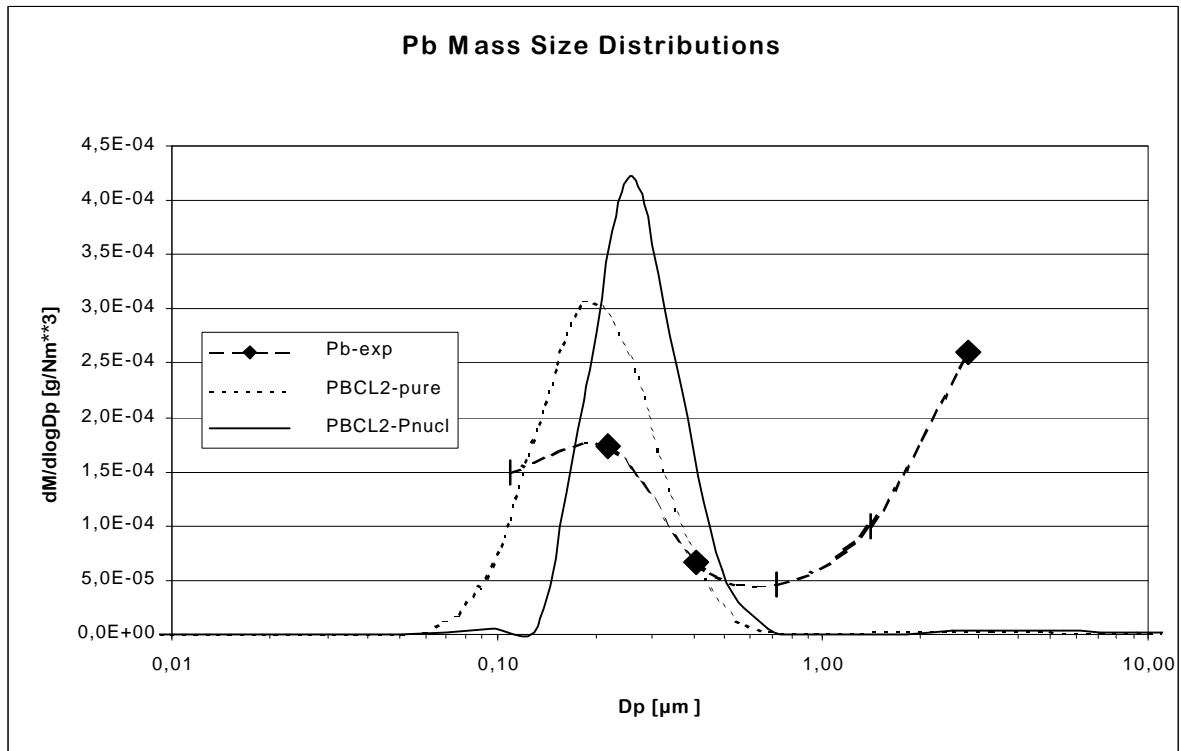

Fig. 3. Comparison between simulated and measured composition for fine particle size mode before the ESP.



Fi

Fig. 4. Comparison between simulated and measured Pb particle size distributions before the ESP (Pnucl is a simulation without any pre-existing ultra fine particles).

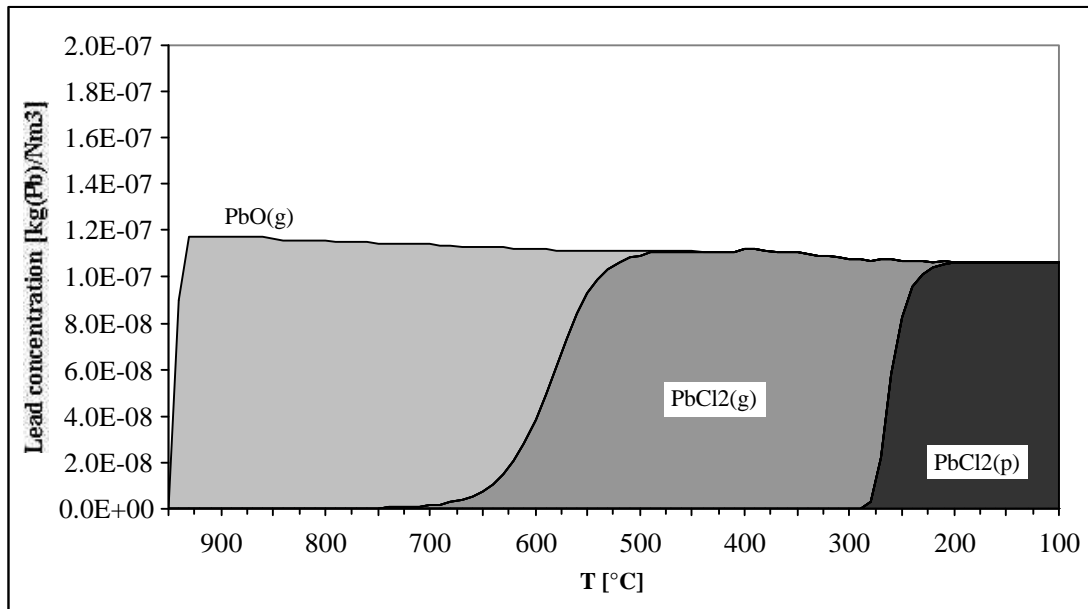
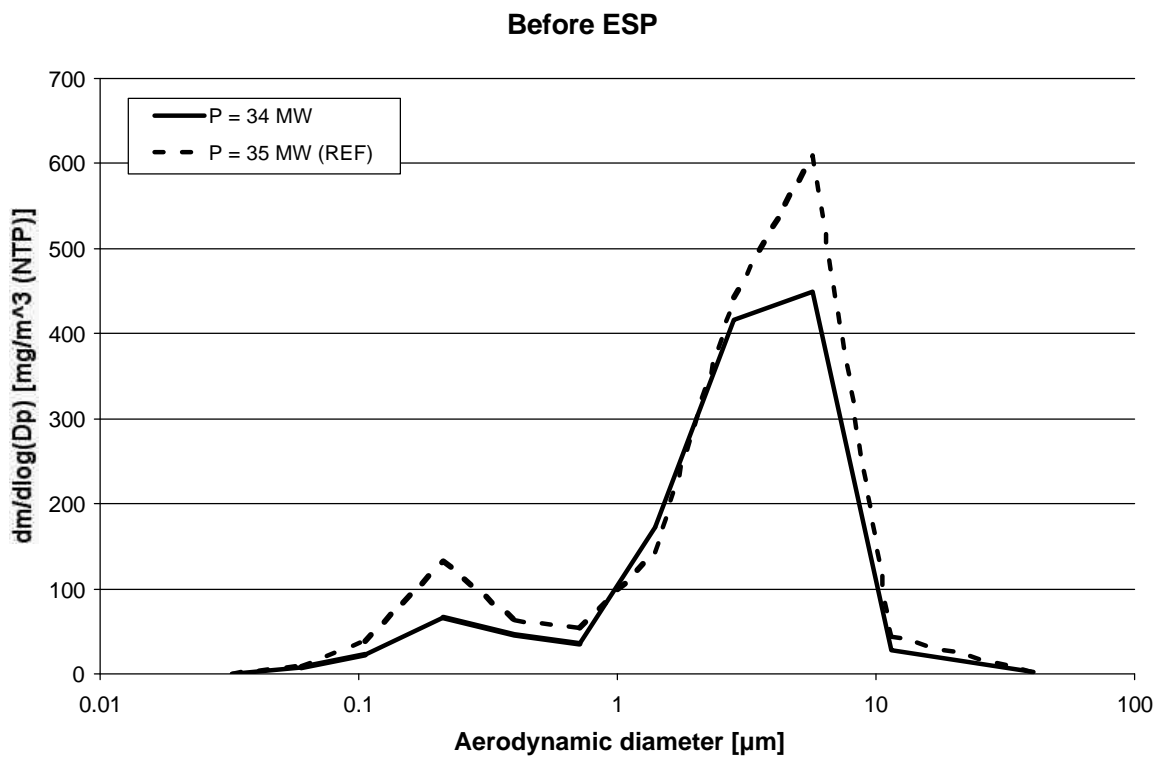
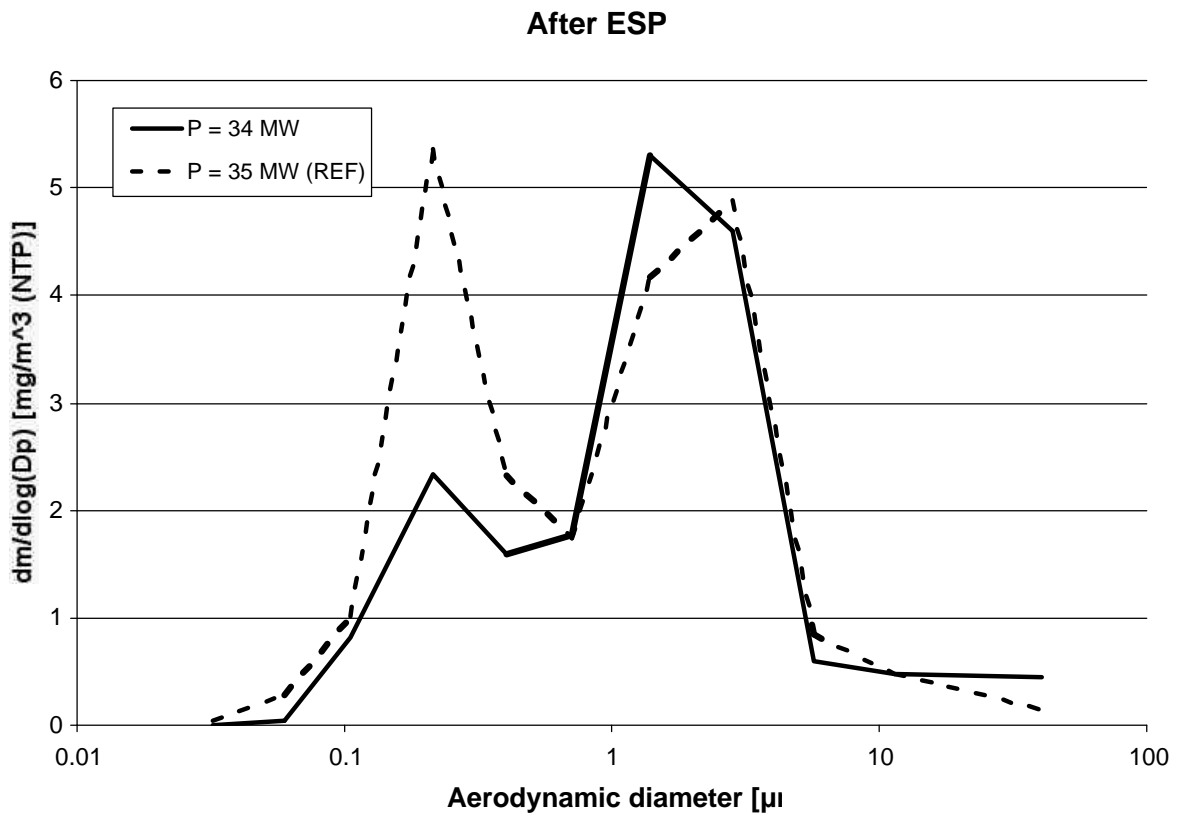

Fig. 5. Simulated Pb speciation as a function of the flue gas temperature.



Figures. 6 and 7. Particle mass size distribution before (6) and after ESP (7).

Fig

PARTICLE SEPARATION FOR BIOMASS COMBUSTION

F. Ebert

University of Kaiserslautern, Gottlieb-Daimler-Str., D-67663 Kaiserslautern
phone 0631/205-2415, fax 0631/205-3055, email ebert@mv.uni-kl.de

ABSTRACT: Mechanisms of particle separation in cyclones, fabric filters, electric filters, wet scrubbers, and flue gas condensation precipitators. Influence of particle size and particle characteristics on separation efficiency in the different separator types. Application of particle separation to biomass combustion with respect to wood (mainly anorganic particles) with low and high water content, and to straw (mainly salts like KCl), and wood waste (Cl and heavy metals). Particle size and characteristics before and after separators.

1. INTRODUCTION

We deal with the separation of particles from raw gases which originate from the combustion of biomass. We have in mind installations for utility purposes with a thermal power in the range from 0,3 to 30 MW - to give orders of magnitude. Putting aside domestic burners we have to notice that also the plant scale range considered suffers from disadvantages which are typical for small combustion plants: Unregular feed of fuel, often strong fluctuations of the burning conditions, relatively high specific investment and operation costs. The properties of the flue gas can vary strongly. (Composition of the gas, content of pollutants, temperature and relative humidity, then characteristics of the particulate matter, e.g. particle size and loading). Thus, efficient removal of pollutants can be substantially impaired. In other words: Apart from the problems inherent to the different kinds of pollutants the relatively small scale of the installations in question makes satisfactory gas cleaning difficult from a functional as well as from an economic point of view.

The different fuels of interest are wood chippings, straw, sawdust, old timber and residual wood of forestry. A rough indication of the size range of ash particles gives Table 1. Hereby, the siftings indicate the part of ash that is collected below the grate of the furnace, correspondingly

„cyclone ash“ and „fly ash“ represent the parts of particulate matter being collected in a cyclone separator and a high efficiency separator respectively, e.g. a fabric filter or an electrostatic precipitator. The chemical composition of the particles varies with size. A tendency, which has been observed also for flue gas dust from other burning processes, can be described as follows:

The content of heavy metals in fly ash can be one to two orders of magnitude higher than in bottom ash. The comparison of fly ash with cyclone ash shows that in case of straw the content of cadmium for the former is 3 – 4 times higher than that for the latter; the same is true for Pb [1]. A similar result has been reported by Valmari et al. [2], who investigated the fly ash formed by fluidized bed combustion of willow. Thus, it is clear that the separation of the fine particle fraction is of particular importance.

A special problem arises with the combustion of straw, which is characterized by a relatively high content of K, Cl und S. In the furnace volatile salts - K_2SO_4 and KCl - are formed, which condense during the cooling of the flue gas. This leads to submicron particles of 200 – 400 nm in diameter. The volumetric number concentration reaches the order of magnitude of 10^7 cm^{-3} [3]. The inconveniences to cope with in this case are twofold:

Table 1. Mass percentage of ash from biomass burning

particle size range (μm)	fuel ash	Bark	Chippings	Saw dust	Straw
> 50	coarse (siftings)	65 – 85	60 – 90	20 – 40	80 – 90
< 10	cyclone ash	10 – 25	10 – 30	50 – 70	2 – 5
< 1 (5)	fly ash	2 – 10	10 – 20	10 – 20	5 – 15

The corrosive conditions in furnace and boiler as well as the difficulty to remove efficiently very fine particles.

The problem of very fine salt particles is well known to manufacturers of particle separation equipment since about two decades. Examples are KCl-particles in sintering plants for steel production or $(\text{NH}_4)_2\text{SO}_4$, NH_4Cl – particles generated in the gas cleaning of coal fired power stations (desulphurization part). In contrast to the biomass burning installations these examples refer to plants of big scale. The flue gas volume rate corresponding to the cited examples is about two orders of magnitude higher than that for biomass burning plants!

Particles carried by exhaust gas can be separated by inertial separators, e.g. cyclones, by electrostatic precipitators, by filters and wet scrubbers (Table 2). For the particle size considered inertial separators are ordinarily not applied because of their low separation performance. On the other hand, one should remark that the inertial separator – in particular the cyclone – is one of the very few options in hot gas cleaning which are suitable for industrial application on a larger scale. If energy consumption is a second order problem, the separation efficiency can achieve a satisfying level also for fine particles. E.g., the conditions can be met for the use of waste gas of coal fired power stations in gas turbines. (Dust loading below 10 mg/m^3 , particle size below $5 \mu\text{m}$.) But also the other three types of separators meet their limits in the submicron range.

In view of the peculiarities of biomass burning a general survey of the different kinds of particle separators seems to be of limited interest, all the more so, as there exists abundant pertaining literature. Apart from surveys appeared in scientific journals, text books with worked out design examples [4, 5] are useful; in this connection, where not only the principle of function but rather the characteristics of practical operation are of interest, the VDI guidelines seem to be useful [6]. Then, the corresponding sections in standard handbooks should be mentioned [7, 8]. In the following, a short description of the different particle separators will be given: characteristics which are pertinent to flue gas of biomass burning shall be emphasized. Further, some new developments, accounting also for the simultaneous removal of particles and gaseous components, will be mentioned. To the authors knowledge all customary kinds of particle separators are applied for biomass flue gas cleaning – with the exception of the wet scrubber (this holds for Germany, Austria and Denmark)!

2. SEPARATION MECHANISMS

The efficiency of a particle separator is measured by quantities characterizing the fineness of the particles removed, e.g. the fractional separation efficiency, which denotes the ratio of the amount of separated particles in a narrow size fraction to the corresponding amount in the feed stream. This function is – on principle – independent of the feed materials size distribution, in other words, it's a characteristic of the separator. In practice, the particle size, for which the grade efficiency amounts to 50 %, is often used to inform about the separator's capability to cope with a given dust. This parameter is called „cut size“. The total separation efficiency gives the part of feed dust that is removed by the device. It is a parameter of limited value because it depends not only on the separator's capability but also on the size distribution of the feed dust. Further, a separator must be assessed by its specific energy consumption, i.e. by the amount of energy needed to clean a certain volume of raw gas (e.g. $\text{kWh}/10^3\text{Nm}^3$). Further, investment and operational costs, criteria for availability, reliability in operation and maintenance have to be accounted for.

2.1 Inertial Separator

We disregard gravity and baffle separators. We concentrate on the cyclone separator whose working principle is simple: The flue gas is set in a spinning flow with relatively high circumferential and low radial velocity components. Particles suspended in the flow exert in radial direction centrifugal forces (outward) and flow forces (inward). Due to the size dependency of the forces (centrifugal forces proportional to x^3 , flow forces proportional to $x^1 + x^2$, with x being the particle size) coarse particles move to larger radii where they are concentrated to be collected; fine particles follow the flow radially inwards. An appropriate flow configuration for the realization of this principle gives the standard cyclone (Fig. 1). Many decades of experience have shown that basic types, characterized by certain values of the ratio of the main dimensions, are particularly appropriate for practical purpose. According to the respective demand – e.g., whether a cyclone should be optimized with regard to separation efficiency or to minimal energy consumption – these ratios are different but vary between moderate limits.

Table 2. Orienting parameters of particle separators

Type	Cyclone	Filter (fabric filter)	Electrostatic precipitator	Wet scrubbers (venturi)
cut size [μm]	~ 5	~ 0.1	~ 0.1	~ 0.1
specific energy [$\text{kWh}/1000 \text{ Nm}^3$]	0.2 – 0.5	0.1 – 1.5	0.5 – 1.5	2.5 – 6.0
investment	low	high	high	low
operational cost	moderate	low/moderate	low	high

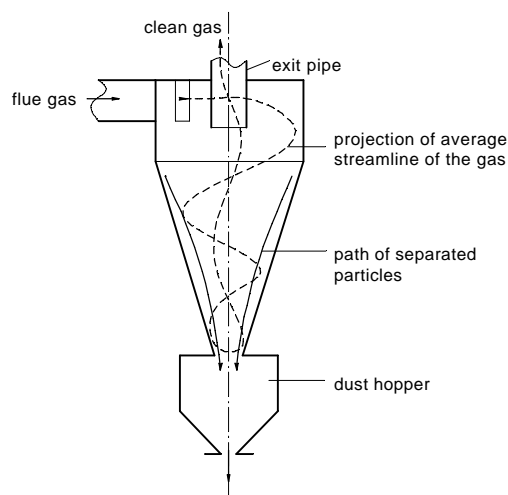

Fig. 1 Standard (reversal) cyclone

Dust loading of the feed gas strongly influences the operation. A desktop design method, backed up by extensive experimental results, has been proposed by Muschelknautz et al. [8]. The cyclone separator is a very robust device, which can be operated under „heavy duty“-conditions. The realizable temperature range comes up to 1300° C. Careful experiments on high temperature operation have been carried out by Lorenz and Morweiser [9 , 10]. These authors propose also a design method which seems to work well for high temperatures. In many cases the cyclone acts as an efficient preseparator that enables proper function of a high efficiency device. Particles down to about 10 µm size can be collected with relatively modest energy demand. It should be noted that a cyclone separator is not very flexible with regard to changes of the operation conditions, in particular to variations of the gas flow rate.

Multicyclone

For a given pressure loss and geometric conditions the cut size is roughly proportional to the cyclones diameter. Thus, one connects a sufficient number of small cyclones in parallel, in order to shift the particles to be collected to smaller sizes (multiple cyclone). Sometimes a multiple cyclone consists of some hundred individual cyclones. Whether favourable operation can be reached, depends on the design of the flue gas feed to the individual separators, the collection of the different clean gas streams as well as of the separated dust. Because of low demand of space, common raw gas plenum chambers with axial inlet to the individual separators are often provided. Also, the clean gas streams are brought together in a plenum chamber. In order to avoid circuit flow inside the dust hoppers between different individual cyclones the static pressure in the clean and the raw gas plenum chambers should be distributed uniformly. In order to realize this, the velocity level in the raw gas plenum chamber must be kept low. Then, the risk of particle deposition cannot be excluded. Multicyclone arrangements offer the possibility to cope with a remarkable drawback of the cyclone – the narrow operational range: Adjustment to load variations can be achieved by disconnecting parts of the system.

Simultaneous removal of particulate and gaseous pollutants

In order to remove particles and gaseous pollutants simultaneously, Spliessgardt et al. [11] have combined a cyclone separator with a filtering element and a catalytic post combustion stage. The authors focus on plants with a thermal power up to 10 MW, the gaseous pollutants they have in mind are hydrocarbons of aliphatic as well as aromatic structure. The salient features of the gas cleaning device are as follows: In a conventional cyclone separator the exit pipe is replaced by a regenerable filter cartridge. The flue gas that has passed this two-stage particle separation system is directed to an annular catalyst bed. Here, the hydrocarbons are converted. Experiments carried out with wood briquettes in a small burning plant (no further detail is given) show that a dust concentration in the clean gas of 2mg/Nm³ can be reached. The catalytic stage converts carbon monoxide almost completely, the reduction of the hydrocarbons amounted to 85 % which seems to be satisfactory.

2.2 Surface filters

We deal with cake generating cleanable surface filters which are utilized to reduce particulate emissions from industrial waste gases, for product recovery and purification of process gases. The filter media are flexible or rigid. In the first case they consist of connected fibers or membranes with holes. In the second one they are produced from fibrous or granular ceramic material in form of candles and cartridges, respectively. The working principle of surface filters is as follows: With the raw gas particles are transported to the filter element. The gas flows through the pores of the filter medium. The particles are separated on the filter medium's surface. A dust cake builds up and causes the pressure drop to increase. If an upper limit for the pressure drop is reached, the dust cake must be removed. This „regeneration“ is performed periodically. It should be stressed that the dust cake itself is an effective filter medium; this means, emissions are highest immediately after cake removal and decrease with cake build up. One of the important parameters is the flow resistance of the filter cake. It depends on the cake structure and, hereby, on the forces between the particles which form the cake.

Surface filters are considered as high efficiency separators. Several means are at disposal to improve or assure the operational behaviour of surface filters. The aim is to guarantee a favourable regeneration of the filter leading to a stable characteristic of the residual pressure loss. The latter is defined as the pressure loss which is observed directly after cake detachment. Hereby, the separation capability is expected to be improved or – at least – not affected. The following possibilities exist:

- a) Preparation of filters by coating; that is, a membrane is arranged on top of a fabric filter, e.g. a common needle felt

b) Conditioning of raw gas

Conditioning can be performed by additives in form of particles, droplets or gas. Also, the application of electric and acoustic fields – promoting particle agglomeration - has been investigated. An actual survey on raw gas conditioning has been given by E. Schmidt [12].

With regard to the coating of filters by a membrane, Peukert [13] reports on experiments concerning the filtration of TiO_2 particles (size about $0,6 \mu\text{m}$). Two filter media are considered: An ordinary needle felt (PTFE) and a needle felt with a PTFE-membrane on top. Both media exhibited the same weight per unit surface (600 g/m^2). It turns out that in the latter case the separation efficiency in the submicron range was increased considerably.

Raw gas conditioning

With regard to raw gas conditioning we consider the adding of particles. Hereby, we distinguish between intermittent and permanent addition. The first concerns the precoating in the case of separation of sticky particles. In order to prevent that sticky particles contact the surface of the filter medium, a layer of inert, non sticky particles is deposited. (Examples: separation of fumes of zinc galvanising plants, tar fumes from anode baking processes.) Also the second, the permanent addition of particles, in particular of fine mineral powders, is indicated in case of sticky submicron particles. (Example: ammonium nitrate, ammonium sulphate particles generated by gas phase reaction in a reactor for the desulphurization and the denitrification of flue gas respectively.) The result is a more porous and stable filter cake, providing better cake detachment from the filter medium.

Simultaneous removal of particulate and gaseous pollutants

Filtration by cake generating surface filters offers the possibility to remove gaseous pollutants as well as particulate matter. As mentioned already, the burning of straw is characterized by a high chlorine and potassium content of the fuel. Sulphur plays also an important role in this connexion. In this case, the flue gas will contain remarkable amounts of KCl and SO_2 respectively. By adding an appropriate sorbent in form of fine particles to the flue gas gaseous pollutants are removed. The absorption takes place in the gas suspension as well as in the filter cake in which the sorbent particles are integrated. Hemmer et al. [14] report on experiments in a test filter unit. The fly ash originates from wood bark, NaHCO_3 and Ca(OH)_2 have been used as sorbents (particle sizes of 3.5 and $20 \mu\text{m}$ respectively corresponding to the 50 % - value of the cumulative particle size distribution (by mass)). In particular, the removal of SO_2 was measured. The results indicate that NaHCO_3 is the better sorbent than Ca(OH)_2 in case of lower temperatures; high conversion rates of SO_2 are achievable; stable filtration can be realized at temperatures below 400°C ; at higher temperatures the

cake becomes sticky and cannot readily be detached from the filter medium.

2.3 Electrostatic precipitators

Particles are separated from the carrier gas as follows: A d. c. voltage field is oriented perpendicularly to the gas flow direction by proper arrangement of electrodes. Charged particles experience an electric field force in direction of the field lines. Thus, they migrate to the electrode with opposite charge sign, where they are deposited (Fig. 2).

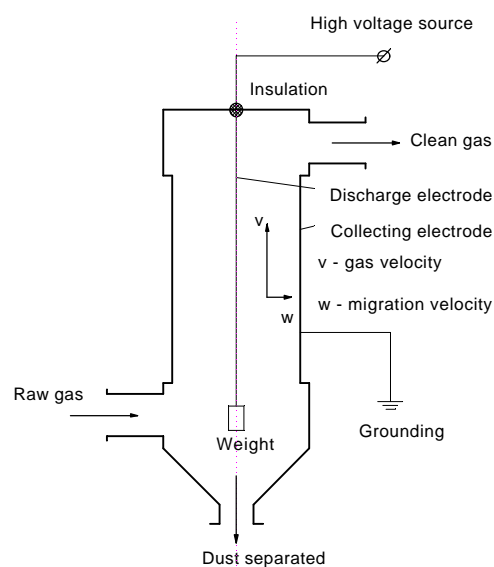

Fig. 2 Tubular electrostatic precipitator

In flow direction, gas and particles possess almost the same velocity v . The velocity w , the migration velocity directed to the collecting electrodes, is determined by the interplay of electric field force and flow force (drag) acting on the particle. The particles receive their charge from negative gas ions that are produced by corona discharge. Depending on the particle size different charging mechanisms prevail: For particle sizes below $0.2 \mu\text{m}$ diffusion charging, for particles greater $1 \mu\text{m}$ field charging dominates. In other words: The ion motion towards the particle due to diffusion contributes the most to the particle charge for the smaller, the ion current due to the electric field is mainly responsible for the charge of larger particles. The migration velocity exhibits a minimum for the transition range between the limiting cases just mentioned. Proper design leads to high separation efficiency over the entire particle size range.

Typical values of the migration velocity cover the range from some cm/sec to some dm/sec. The flow velocity lies between 0.5 and 2.5 m/sec . The distances between the discharge electrode and the collecting electrode amount to $100 - 150 \text{ mm}$ for tubular precipitators, to $100 - 250 \text{ mm}$ for plate-type precipitators.

The following operational conditions must be taken into account: In order to achieve a high separation efficiency a

high field strength and correspondingly a high voltage is desired. An upper limit for the voltage is given by the flashover voltage. Therefore, the voltage is adjusted to a level just below the flashover limit. In industrial flue gas cleaning the discharge electrode works as an anode, this means a negative corona discharge. Hereby, a higher flashover voltage compared with positive corona discharge follows, what results in higher electric field forces.

In „dry“ electrostatic precipitation the particles deposited on the collection electrode form a layer which must be removed periodically. This is done by rapping. The operational behaviour is strongly influenced by the electric resistivity of the particle layer. For favourable operation the specific electric resistivity has to lie between the limits of 10^7 and 10^{11} Ω cm. Smaller values lead to particle bouncing and – in consequence – to redispersion into the gas stream due to polarity reversal when the particle contacts the electrode; higher values lead to the so called back-corona due to breakthrough in the high-resistivity dust layer. Hereby, positive gas ions form, that affect the negative charge of the particles. Thus, separation efficiency drops down. The specific electric resistivity is an important design parameter which usually is measured by a special device. This allows to determine this value for conditions as closely as possible to the practical working situation (temperature, humidity, gas composition – SO_3 , NH_3 !) „Wet“ electrostatic precipitation is characterized by a liquid film that covers the collecting electrode [15]. Accordingly, these devices are designed as vertical tubular precipitators, the collecting electrode being a tube of cylindrical cross section or a honey comb pattern with hexagonal cross section of the elements. The liquid film discharges the corona current and removes the separated dust. The liquid film can be generated by droplets carried by the raw gas, by intermittent spraying, by condensation or by an overflow system. The liquid is collected at the bottom for further treatment. The function principle implies that the gas is saturated, so the operational temperatures lie remarkably below 100°C .

In order to improve the separation efficiency and to establish favourable operational conditions some measures can be taken. Hereby, we start from the high level of know-how of which the manufacturers of electrostatic precipitator dispose with regard to the shape of discharge electrodes, collecting electrodes, flow geometry and – in particular – high voltage control (the latter accounting for variations of the feed and its state). In particular for biomass burning the conditioning of the flue gas comes into question: First, in view of the experience of many years with application in cement industry, steel production and nonferrous smelters the adding of water can be labeled as „classical“. A quench installed upstream of the precipitator evaporates water; this lowers the gas temperature and increases the humidity. So, the specific electric resistivity of the dust layer decreases. The risk of flashover decreases also what allows to apply a higher voltage. Thus, the separation efficiency is favoured. The conditioning of the flue gas by means of the adding of SO_3 can be taken into consideration. On principle, the injection of SO_3 (< 30

ppm by volume) it leads to a decrease of the specific electric resistivity with the favourable consequences indicated in the foregoing.

2.4 Wet scrubbers

Wet scrubbers are commonly used in waste-gas cleaning. They preferably are applied, if – beside solid contaminants – gaseous contaminants are to be removed. Furthermore, they are particularly suitable if the crude gas is wet saturated or consists of an explosive gas mixture. Among the advantages of wet scrubbers can be named: low investment costs, modest demands on space, simple operation. Usually, different types of wet scrubbers are distinguished (spray towers, ejector scrubbers, self-induced spray type scrubbers, rotating disk scrubbers, disintegrator scrubbers and venturi scrubbers). The basic separation process – dust particles contact the surface of droplets due to inertial effects – is common to all wet scrubbers. Differences show up in the realization of the individual steps:

- dispersing the scrubbing liquid into the gas stream to be cleaned
- bringing into contact both disperse phases (dust particles and scrubbing liquid mostly in form of droplets)
- retention of the dust particles by the droplets
- removing the droplets from the gas stream

Wet scrubbers suffer from the following disadvantages: They demand the treatment of the scrubbing liquid (the same is true for wet-type electrostatic precipitators!). This causes additional investment and operational costs. Of course, the water treatment is governed by environmental regulation. The specific costs of gas cleaning plants – in this case extended by a water treatment installation – increase with decreasing size of the plant. Thus, the willingness to choose a wet scrubber seems to be limited. Another point is, that high efficiency cleaning (with regard to submicron particles) is connected with high specific energy consumption. This holds in particular for the venturi scrubber. Otherwise, the wet scrubber is particularly suited for flue gas of high relative humidity. This can happen e.g. in case of the combustion of wood chippings which exhibit a high moisture content ($\sim 30\%$). The other argument that favours the wet scrubber is its capability to remove efficiently acid gaseous components (SO_2 , HCl).

In our laboratory we have investigated the „nozzle scrubber“ [16]. The flue gas passes a channel in which pneumatic nozzles are arranged. They provide a spray of droplets with diameters of about $30\ \mu\text{m}$, whereby the droplet spray jet promotes a rather high turbulence level. In addition to the usual inertial separation the turbulence induced separation improves the efficiency remarkably. Fractional separation efficiencies of more than 90% for particles with a size of $400\ \text{nm}$ could be achieved. Hereby, the specific water consumption amounted to $0.2\ \text{kg/kg}$ gas. This is almost an order of magnitude less in comparison to a conventional venturi scrubber of corresponding separation efficiency. Also, the specific

energy costs proved to be more favourable. It can be lowered further, if the nozzles, operated by rather expensive pressurized air, are replaced by particular nozzles with high liquid pressure and low air pressure level.

3. CONCLUDING REMARKS

Biomass combustion is realized in the framework of relatively small decentralized stations. It is characterized by regionally and seasonally varying fuel supply. The different kinds of biomass fuel exhibit distinct differences in chemical structure, moisture and ash content. The combustion is connected with an acid ambience, so that the corrosion risk must be taken into account by the plant designer. With respect to emission control acid gaseous components play a major role. The separation of particulate matter poses particular problems in the fine (sub-micron) fraction because of their chemical composition (salts!) and the content of heavy metals respectively. Most of these problems have been encountered in other fields of combustion. Thus, the manufacturers of gas cleaning equipment dispose – on principle – of know-how to offer solutions. Open questions – difficult enough to answer – remain in the fields of operational behaviour and the economical limitations.

REFERENCES

- [1] Oberberger, I.: in Thermische Biomassenutzung – Technik und Realisierung, VDI Berichte 1319, (1997) 47
- [2] T. Valmari, E.I. Kauppinen, J. Kurkela, J.K. Jokeniemi, G. Sfiris, H. Reviker: Fly ash formation and deposition during fluidized bed combustion of willow, *J. Aerosol Sci.* 29 (1998) 4, 445 – 459
- [3] K.A. Christensen, M. Stenholm, H. Livbjerg: The formation of submicron aerosol particles, HCl and SO₂ in straw-fired boilers, *J. Aerosol Sci.* 29 (1998) 4, 421 – 444
- [4] F. Löffler: Staubabscheiden, Stuttgart/New York, 1988
- [5] W. Licht: Air pollution control engineering: basic calculations for particulate collection, 2. ed., New York 1988
- [6] VDI-Richtlinien (VDI-Guidelines), VDI Düsseldorf (In German and English)
 - a) VDI 3676, Inertial separators 1999
 - b) VDI 3677, Filtering separators, surface filters 1997
 - c) VDI 3678, Electrostatic precipitators, Process and waste gas cleaning 1998
 - d) VDI 3679, Wet separators for particle collection 1998
 Publishers: Beuth, Berlin
- [7] Perry's Chemical Engineers's Handbook, 6. ed., Ed.: Don W. Green, New York, 1999
- [8] E. Muschelknautz, M. Trefz: Druckverlust und Abscheidegrad im Zyklon, VDI-Wärmeatlas, Abschnitt Lj; 6. Auflage, Düsseldorf 1991
- [9] T. Lorenz: Heißgasentstaubung in Zyklonabscheidern VDI Fortschrittsberichte Reihe 3, Nr. 366, Düsseldorf 1994
- [10] M. Morweiser, M. Bohnet Hot Gas Cleaning with Aerocyclones under Pressure Conditions, Preprints 3rd. Europ. Symp. Separation of Particles from Gases, Ed. F. Ebert, PARTEC 95, Nürnberg, 21-23 March 1995
- [11] M. Spliessgardt, R. Schulz, H. Cramer, K. Görna: Untersuchungen zur kombinierten Staub- und Schadgasabscheidung bei der energetischen Nutzung von Biomasse, Gefahrstoffe – Reinhaltung der Luft 58 (1998) S. 297-302
- [12] E. Schmidt: Verfahren zur Konditionierung von Rohgasen“ Teil 1: Konditionierung durch elektrische Maßnahmen, *Chem. Ing. Tech.* 73 (2001), S. 159-170, Teil 2: Konditionierung durch akustische Maßnahmen, *Chem. Ing. Tech.* 73 (2001), S. 322-326, Teil 3: Konditionierung durch Dosierung von Feststoffen, Flüssigkeiten oder Gasen
- [13] W. Peukert: Recent developments in Surface and Bag Filtration Proc. Int. Symp. Filtration and Separation of Fine Dust, Vienna, April 1996, Ed. W. Höflinger
- [14] G. Hemmer, Y. Wang, G. Schaub, G. Kasper: Combined Dry Removal of Particles and Gaseous Pollutants from Biomass Combustion, Int. Congress for Particle Technology (PARTEC), Nürnberg, 27 – 29 March 2001, Proceedings
- [15] K. Hasselwander, R. Skroch, G. Mayer-Schwinning: Wet ESPs, Status and Latest Developments in the Field of Aerosol Collection, PARTEC 98, 4th European Symp. Separation of Particles from Gases, S. 326-335, Nürnberg, 10-12 March 1998, Preprints Ed. F. Ebert
- [16] F. Ebert, H. Büttner: Recent investigations with nozzle scrubbers, *Powder Technology* 86 (1996) S. 31 - 36

OVERVIEW OF PROJECTS ON AEROSOLS FROM BIOMASS COMBUSTION IN SWEDEN

C. Tullin¹, L. Johansson¹ and Iréne Wrande²

¹SP Swedish National Testing and Research Institute, Box 857, SE – 501 15 Borås, Sweden

phone +46 (0)33 16 50 00, fax +46 (0)33 13 19 79, email claes.tullin@sp.se

²Swedish National Energy Administration, Box 310, 631 04 Eskilstuna, Sweden

ABSTRACT: In Sweden, biomass combustion in small as well as large scale is expected to be important in the transformation to tomorrow's sustainable society. However, today's use, especially in the domestic sector, may lead to substantial local pollution. In fact, small-scale wood combustion in Sweden results in annual particulate emissions in the same range as from traffic. This is mainly a consequence of the large number of old boilers still in use. However, in addition to technology, the environmental impact depends on a number of factors, for instance fuel quality, installation and operation. Very few field measurements are available and there is a need to quantify and characterize the emissions in detail. Accurate data can be used to evaluate the need to implement the best available technology and to develop new technology. This is true for domestic scale operation as well as for smaller district heating plants with limited flue gas cleaning. In order to resolve these issues a new research programme, "Biofuels, health and environment," has recently been initiated. In this paper, a short overview of this programme is given.

Keywords: Biomass combustion, aerosols, Sweden, research programme

1. INTRODUCTION

The total use of bioenergy corresponds to about 100 TWh or 20% of the total energy supply in Sweden. In district heating, 22 TWh out of 51 TWh is based on biofuels, mainly forestry residues. Heating of one-family houses corresponds to about 50 TWh out of which 12 TWh or 25% derives from small-scale biomass combustion.

Domestic scale boilers are not equipped with devices for flue gas cleaning. Furthermore, most of the domestic boilers are based on old technology and are not equipped with heat storage tanks. In these boilers, the load is controlled by the supply of combustion air which results in high emissions of tar, hydrocarbons and particulate matter when compared to modern boilers. Emission factors for tar, VOC, NO_x and particulates for various domestic heating devices have been presented by Gustavsson *et al.* [1]. In smaller district heating plants (up to a few MW), the flue gas cleaning is often limited to the use of (multi)cyclones. Converting small scale oil combustion to biomass results in higher emissions of particulates.

The data regarding real emissions from old boilers are scarce, not least regarding the emissions of particulates. In general, the particulate emissions from various biomass fuels as well as the physical characteristics (form, particle size distributions etc.) and chemical composition of these particulates are not known in detail [2, 3]. In Sweden, the annual emissions of particulate matter from wood combustion have been

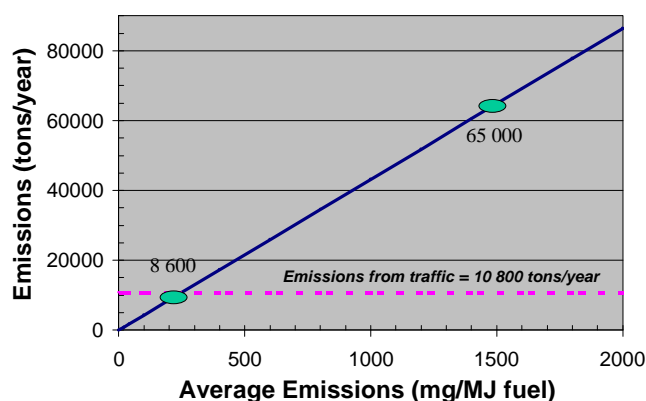

Figure 1. Total particulate emissions in Sweden from small-scale wood combustion for various average emission factors. It is assumed that the annual small-scale wood combustion corresponds to 12 TWh.

estimated to be between 8 600 and 65 000 tons [4]. The corresponding emissions from the traffic is 10 800 tons (this number is related to the exhaust emissions and excludes particles generated from tires, brakes etc.). The uncertainty in these numbers is illustrated in Figure 1. It can be noted that at an average boiler emission of 250 mg/MJ fuel supplied, the particulate emission is equal to that estimated for the traffic. For old direct fired boilers

(which are still the most common domestic boiler type), this figure is probably higher. On the other hand, the figure also illustrates the potential emission reduction. In a modern wood boiler, the particulate emission can be as low as 10 to 20 mg/MJ fuel supplied. Thus, based on modern technology, the annual emissions could be well below 1 000 tons per year. However, it should be noted that in addition to technology, the real emissions depend on a number of factors such as fuel quality, adequate installation of the equipment, operation and maintenance. The Swedish Parliament has established 15 objectives for environmental quality that describe the qualities our environment and our common natural and cultural resources must have in order to be ecologically sustainable. In one of these objectives, “clean air,” ambient air limits are set for a number of pollutants, i.e. particulate matter, VOC (volatile organic compounds), carcinogenic substances (benzene, benz(a)pyrene, ethene), nitrogen dioxide, sulphur dioxide and ground level ozone [5]. With respect to particulates, it is stated that “In 2020 concentrations of particulates in the air must not exceed levels that may damage human health, cultural values and materials.” In order to achieve this target, the following limits are suggested:

- Levels of inhalable particulates, PM₁₀, should be less than 30 microgram/m³ as a 24-hour mean value and 15 microgram/m³ as an annual mean (health)
- Soot levels should be less than 10 microgram/m³ as an annual mean value (cultural values and materials)

Biomass is definitely one of the renewable energy sources that will be used in tomorrow's sustainable society. However, it is also clear that a sustainable and environmentally safe use of biomass requires more knowledge regarding real emissions from boilers in normal operation, particulate characteristics, ambient air concentrations, health impact etc.

2. RESEARCH PROGRAMME EMISSIONS AND AIR QUALITY

The long term objective with the research programme “Emissions and Air Quality” is to contribute to an increased use of renewable fuels at the same time as the Swedish Environmental Quality Objectives [5] are satisfied. As part of this programme a number of projects are coordinated in a separate subprogramme named “Biofuels, Health and Environment” which was initiated during the spring 2001. The projects are grouped in three different clusters, i.e. (see appendix 1 for a complete list of ongoing projects):

- Emissions from biomass combustion
 - Laboratory measurements
 - Field measurements
 - Emission modelling

- Ambient air
 - Source-receptor model
 - Atmospheric chemistry model
 - Emission data base
 - Mapping of ambient air quality
- Health effects
 - Epidemiologic studies
 - Risk Studies

A separate project has been initiated to coordinate the work. In addition, with the objective to catalyse the information exchange between researchers of different disciplines a network has been established. The network recently had its first symposium and a website has been opened [6].

2.1 The emission cluster

With respect to projects concerning emissions, there are also projects included with funding from other programmes and financial institutions (cf. appendix 1). The objectives with the emission cluster projects are:

- To produce and validate emission models for small-scale biomass combustion units (i.e. from domestic scale to small-scale district heating plants).
- Map and characterise the emissions in two Swedish towns, i.e. Växjö and Lycksele.
- To give input to the need to implement BAT (best available technology) and to develop new technology.

The domestic-scale combustion devices to be investigated comprise wood log boilers (direct fired as well as in combination with a heat storage tank) and wood stoves of different types, pellet burners and pellet stoves as well as small-scale district heating plants of different types and with different flue gas cleaning. The effect of various fuel qualities will also be considered. In addition to particulates, the gaseous emissions will be characterised in detail. The number and types of domestic-scale boilers and stoves in Växjö and Lycksele will be surveyed in detail. In cooperation with the chimney-sweepers quite extensive field measurements of CO-levels will be carried out. Due to the diversity of small-scale combustion units, extensive field measurements are necessary. To characterise the real emissions in detail simplified methods need to be developed. The idea is to identify and measure a few components (that can be correlated to other components) in a simple and cost effective way so that a sufficient number of field measurements can be performed in order to produce statistically solid data. The projects will therefore involve laboratory tests in order to develop and validate these simplified methods. A few detailed field measurements will also be performed for validation purposes.

The data from the emission cluster will be utilised in the projects in the ambient air cluster. It has also been discussed to if possible coordinate a measurement of the

emissions with ambient air emissions down stream (300-500m) of the source.

Results from ongoing projects are presented in separate presentations [7,8].

REFERENCES

- [1] Gustavsson, L, Tullin, C, Wrande, I.: Small-scale biomass combustion in Sweden- Research towards a sustainable society," *1st World Conference and Exhibition on Biomass for Energy and Industry*, Sevilla, 5-9 June
- [2] Tullin, C., Johansson, L., Johansson, J., Johansson, M. and Svedberg, P.: Literature survey on particulate emissions from biomass combustion, *Swedish National Energy Administration*, Report no. ER 9:2000.
- [3] Tullin, C., Johansson, L. and Leckner, B.: Particulate emissions from small-scale biomass combustion, *Nordic Seminar on Small Scale Wood Combustion*, Näändal, Finland, 17-18 February
- [4] Hansson, C., Westerholm, R. and Kyrklund, T.: Airborne particles in the ambient environment, Swedish Environmental Protection Agency, Report 4804 "Particles in the ambient air as a risk factor for lung cancer," Editor P. Camner, ISBN 91-620-4804-x₂, pp. 13-35, 1997.
- [5] Swedish Environmental Protection Agency, website: <http://www.internat.environ.se/index.php3>
- [6] Network website: <http://itm12.itm.su.se/natverket/home.html>
- [7] Johansson, L., Tullin, C., Leckner, B.: Particulate emissions from small-scale biomass combustion, *Seminar on aerosols from biomass combustion, Proceedings*, Zürich, June 27, 2001.
- [8] Sanati, M.: Investigation on aerosol formation and cleaning efficiency in commercially operated biomass fired boilers, *Seminar on aerosols from biomass combustion, Proceedings*, Zürich, June 27, 2001.
- [9] The Swedish National Energy Administration, web site: www.stem.se

APPENDIX

The Swedish National Energy Administrations Research Programme on Emissions and air quality- ongoing projects [9]:

Coordination and information exchange

"Biomass combustion emissions – Health – Environment, synthesis and coordination," Hans-Christen Hansson, Stockholm University

An R&D network for particulate air pollution from the energy and transport sectors
Hans-Christen Hansson, Stockholm University

Emissions¹

"Particulate emissions from smaller district heating plants," Claes Tullin, SP Swedish National Testing and Research Institute²

"Formation and emissions of PM₁₀ from biomass combustion," Claes Tullin, SP Swedish National Testing and Research Institute

"Particle emission from small scale biomass boilers – Basis for effective air quality management," Mehri Sanati, Växjö University

"Aerosol formation and effects during biomass combustion and gasification," Mehri Sanati, Växjö University

"Field emission measurements from small-scale combustion," Bengt-Erik Löfgren/Henry Hedman, Äfab/ETC

"Quantification and characterisation of actual emissions from small-scale biomass combustion," Lennart Gustavsson, SP Swedish National Testing and Research Institute

"Characterisation of particle and hydrocarbon emissions from small-scale biomass-fired boilers," Magnus Berg, TPS

¹ The projects in the emission cluster are coordinated and co-financed by the programme on "Small-Scale Biomass Combustion."

² Financed by Swedish National Energy Administration, Värmeforsk, Borås Energi and SP

“Characterisation of particle and hydrocarbon emissions from small-scale biomass-fired boilers,” Jan Pettersson, Gothenburg University

“Emissions from the small-scale combustion of biomass fuels – extensive quantification and characterisation,” Anders Nordin, Umeå University

“Continuous measurement methods for dust in flue gases,” Henrik Harnevie, SwedPower AB

“Surveying the use of biofuels in detached houses in Lycksele and Växjö,” Bengt-Erik Löfgren, Äfab

Ambient air

“Planning, performance, and evaluation of a project for measurement of inhalable particulate concentrations in Sweden,” Hans Christen Hansson, Stockholm University.

“Environmental impact assessment of wood burning in residential areas – Tools for local government planning,” Curt-Åke Boström, IVL

“An air quality monitoring strategy for small-scale biomass combustion: cost-efficient methods of measurement and measurement strategies,” Eva Brorström-Lundén, IVL

“Evaluation of the local air quality situation in Lycksele,” Lars Beckman, Lycksele District Council

“Emissions of air pollutants in Lycksele and Växjö,” Malin Pettersson, local authority in Stockholm

“Measurements of air pollution concentrations and validations of calculations,” Christer Johansson, Stockholm University

“Ultra, ultrafine and fine particles in urban air,” Valentin Foltescu, Chalmers University of Technology

“Model tools for dispersion of particles and combustion emissions on national, urban and local scale,” Joakim Langner, SMHI

“Developing guidelines and methods for integrating energy considerations in physical planning,” Cecilia Henriksson, Inregia AB

“Strategic environmental impact assessment of local energy systems,” Anders Mårtensson, Linköping University

“Strategic environmental impact assessment, methodology and implementation within the energy sector,” Göran Finnveden, FOA

“Potential and environmental effect of increased use of biomass fuels,” Gerd Grip, Inregia AB

“Evaluation of the work of air quality monitoring/improvement in Växjö from 2001-2003,” Maria Widholm, Växjö District Council

“Siting combustion plant – a planning aid for an improved environment and better energy efficiency,” Ulf Ranhagen, Luleå University of Technology

Health

“Exposure to benzene and other carcinogenic compounds, before and after change from domestic wood firing,” Lars Barregård, Gothenburg University.

“Particles and acute respiratory effects – air quality is defined by its impact,” Bertil Forsberg, Umeå University

“Cancer risks associated with the use of bioenergy,” Margareta Törnqvist, Stockholm University

INVESTIGATIONS ON AEROSOLS FROM BIOMASS IN THE UNITED STATES

L. Baxter

Brigham Young University, Provo, UT 84602, USA

ABSTRACT (edited by T. Nussbaumer):

Information on health impact of aerosols from USA are presented which show that aerosols in the ambient air are regarded as relevant for bronchitis, asthma and increased mortality (consequences of open and closed steel mill, Pope 2000 and the six-city study, Docker et al. 1993).

Experimental investigations showed that the composition of the particulates varies with size (Skrifvars et al 2000, TEKES) and that the fuel composition influences the aerosol formation. Chlorine in the fuel can significantly increase the release of submicron particulates as shown in Fig. 1.

The following topics are regarded as major unresolved problems in the field of aerosols from biomass combustion:

- Role of secondary versus primary particles
- Role of composition, shape, etc. in addition to amount
- Formation mechanisms other than vapor condensation
- Capture efficiencies in commercial systems
- Deposition mechanisms and rates.

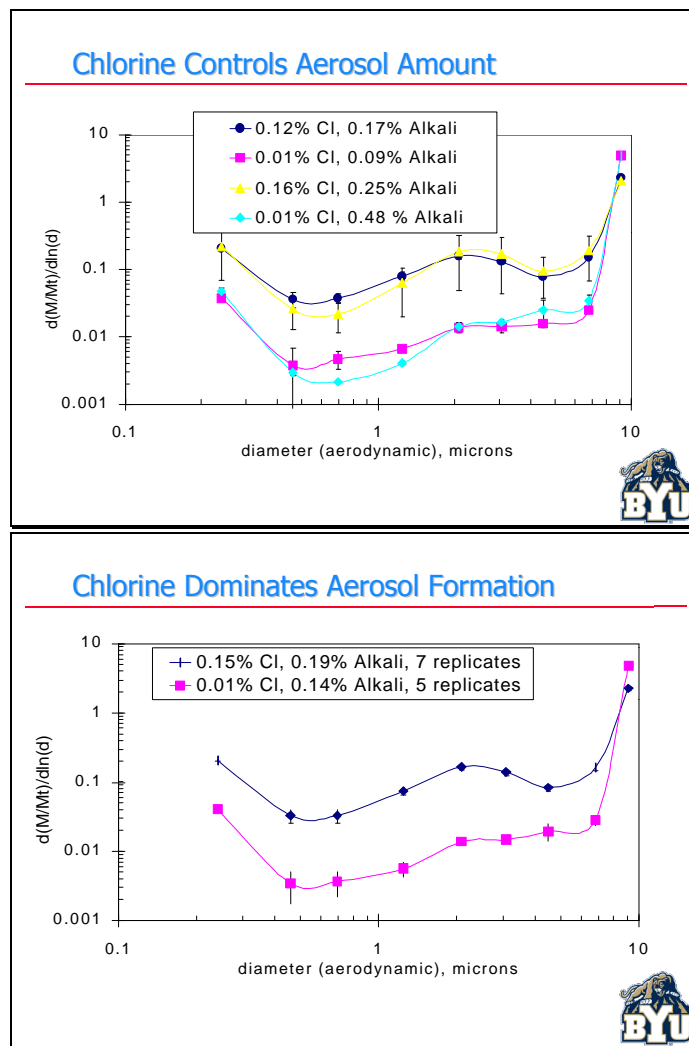

Figure 1: Chlorine controls aerosol amount

OVERVIEW OF INVESTIGATIONS ON AEROSOLS FROM COMBUSTION (INCLUDING BIOMASS) IN GERMANY

Chr. Ehrlich, G. Noll, W.-D. Kalkoff

Landesamt für Umweltschutz Sachsen-Anhalt, Halle (Saale), Germany,
phone +49(0)345 5704500, fax +49(0)345 5704505, e-mail ehrlich@lau.mu.lsa-net.de

1. INTRODUCTION

Recent epidemiological studies have shown that fine particles in ambient air are more harmful than it was supposed to be. Therefore the latest legislation of the EC [1] includes PM 10 limit values at a low level. In Germany and in other European countries there are gaps in keeping these demanding goals. For the gap closure it is necessary to carry out research into fine particle emission data. Emission measurement investigations have been carried out into various industrial sources like cement kiln (industry), secondary copper smelter, glass industry, wood combustion, different coal fired power plants and into small scale domestic heating units with the help of cascade impactors (8-stage and 6-stage). In total 224 emission measurements at 37 industrial plants and 4 domestic stoves have been evaluated. Measurements at biomass combustion were carried out at 16 different installations including 67 emission measurements [4].

The measurement programmes contain measurements at industrial sources with a high proportion of the total dust emission in several German states, like Saxony-Anhalt [2], Bavaria [3], Baden-Wuerttemberg [4] and Saxony [5]. Further measurements were carried out at installations, whose dust emissions include health-relevant substances like heavy metals and metalloids. First results have already been presented [6], [4].

In the new German States and in future EC member states like the Czech Republic, Poland and others, brown coal briquettes are still frequently used for heating domestic stoves. Therefore fine dust emissions were measured at an iron stove where different briquette sorts were used. Emission measurement of wood burning in domestic stoves and small scale combustion units was also included in the programme.

2. EXPERIMENTAL

2.1 Sampling and analysis

The sampling was carried out with the help of 8-stage or 6-stage Anderson impactors type Mark III (material: stainless steel) and/or with the help of a 6-stage impactor of the Stroehlein company type STF 1 (material: titanium). Preliminary tests had shown that the particle size distribution, detected with these two impactors, coincides under same sampling conditions.

Both impactors are heatproof up to 850 °C. For the particle sampling perforated sampling plates and backup filters, made of glass fibre material, were used. The gas volume flux, sucked into the impactor, was measured with a thermal mass flow meter.

The sampling and analysis of the particle measurements were carried out in accordance with the German guideline VDI 2066 Bl 5 [7]. In order to be able to determine the necessary sampling periods for the impactor measurements, at first the emission concentration of the total dust was measured. Thus on the one hand, overloading of the impactor stages should be prevented, on the other hand, a sufficient dust mass per impactor stage to permit weighing with sufficient accuracy should be collected.

To avoid very different loadings of the individual sampling plates, preliminary tests had been carried out in order to take corresponding measures for the actual sampling (e.g. modification of the sampling period, application of a pre-separator). Because at the industrial plants, which were investigated, small emission concentrations of total dust were found, sometimes very long sampling periods (as many as 18 hours, in rare cases 52 hours) were necessary to guarantee a sufficient filter covering.

On the other hand, the high dust loadings in the waste gas of the investigated iron stove (coal fired residential heating unit) required the determination of a sampling period, which was substantially shorter than the time for the complete burn-up of the fuel. Our own investigations have shown that in the first third of the combustion cycle (in this time the impactor measurements were carried out) the emission of the particles was almost complete. The impactor measurements were carried out as grid measurement according to the principles of guideline VDI 2066 Bl. 1 [8]. Only measuring points with approximately the same gas velocity were sampled. In rare cases this led to corrections of the number of measuring points. In the periods of the impactor sampling the operating parameters were recorded.

2.2 Quality assurance measures

All tests were accompanied by a set of quality assurance measurements according to DIN EN 45001 [11]. All pollutant emissions were detected with standardised measuring procedures (VDI guidelines, DIN EN). If applicable, certified continuously operating measuring instruments were used. The parameters of the sampling, the analysis as well as the operational parameters, necessary for the evaluation of the detected emission concentrations, were recorded [3], [4], [5], [12], [13] according to the specifications of the standard form of the test report.

3. RESULTS AND DISCUSSION

Within the framework of the measuring programmes for the following types of industrial installations fine dust emission determination has been carried out and has been analysed:

- heat production, energy (brown coal combustion, biomass (wood) combustion)
- the industry of building materials
- ceramic and glass industry
- production and processing of steel, iron and other metals
- chemical industry

The analysis of these measurement programmes shall contribute to and deepen technology-referred knowledge of particle size distributions of emitted particle types in exhaust gases.

3.1 Typical particle size distribution of the emission samplings

In the following figures the particle size distribution of the particular emission samplings in the distribution grid of Rosin-Rammler-Sperling-Bennett (RRSB) is shown. To give an average out of the particular size distribution is very difficult because of different aerodynamic diameters which are determined at each individual measurement. So only some representative distribution graphs can be shown.

In figure 1 the particle size distribution of industrial power stations shows that the fluidised bed combustion results in a lower fine dust proportion in the diameter range $< 4 \mu\text{m}$ but in a higher proportion for $d_{ae50} > 4 \mu\text{m}$.

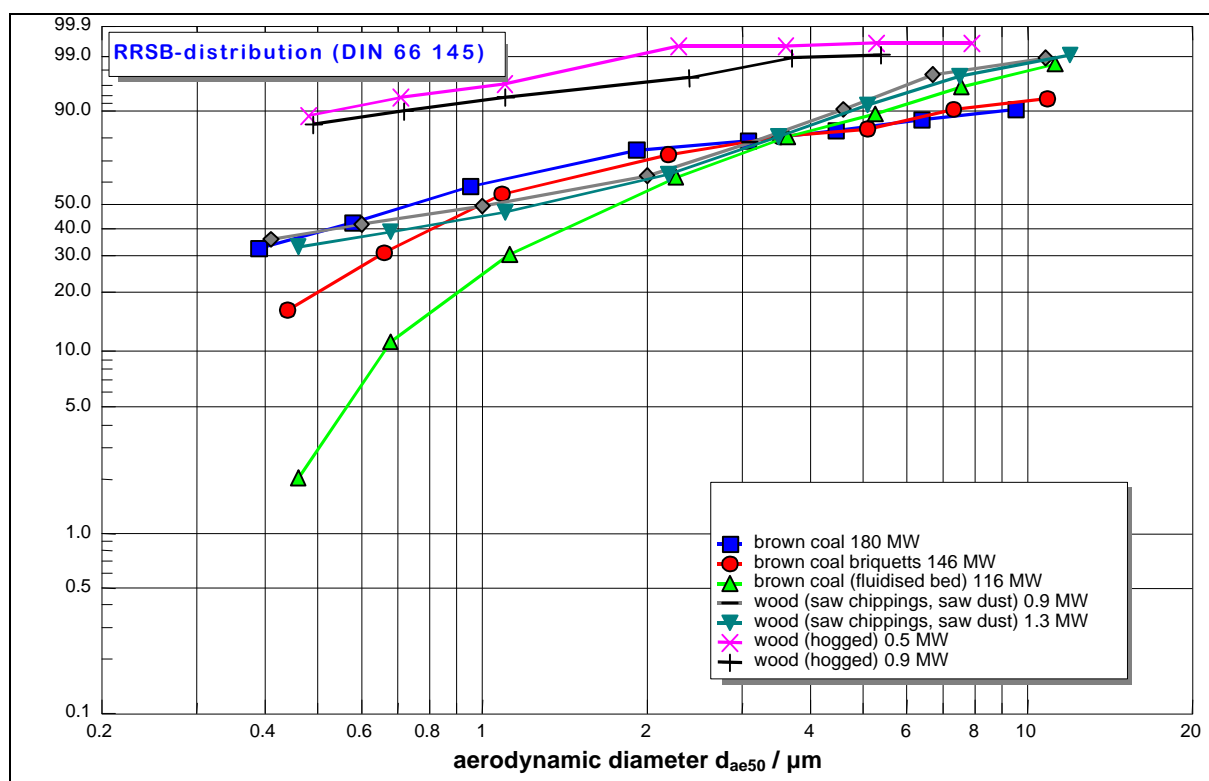

Figure 1: Coal Combustion versus Wood Combustion

In figure 2 the particle size distribution of small scale firing units is shown. The influence of the fuel is significant.

The wood fuel results in finer particles in proportion to the coal fuel.

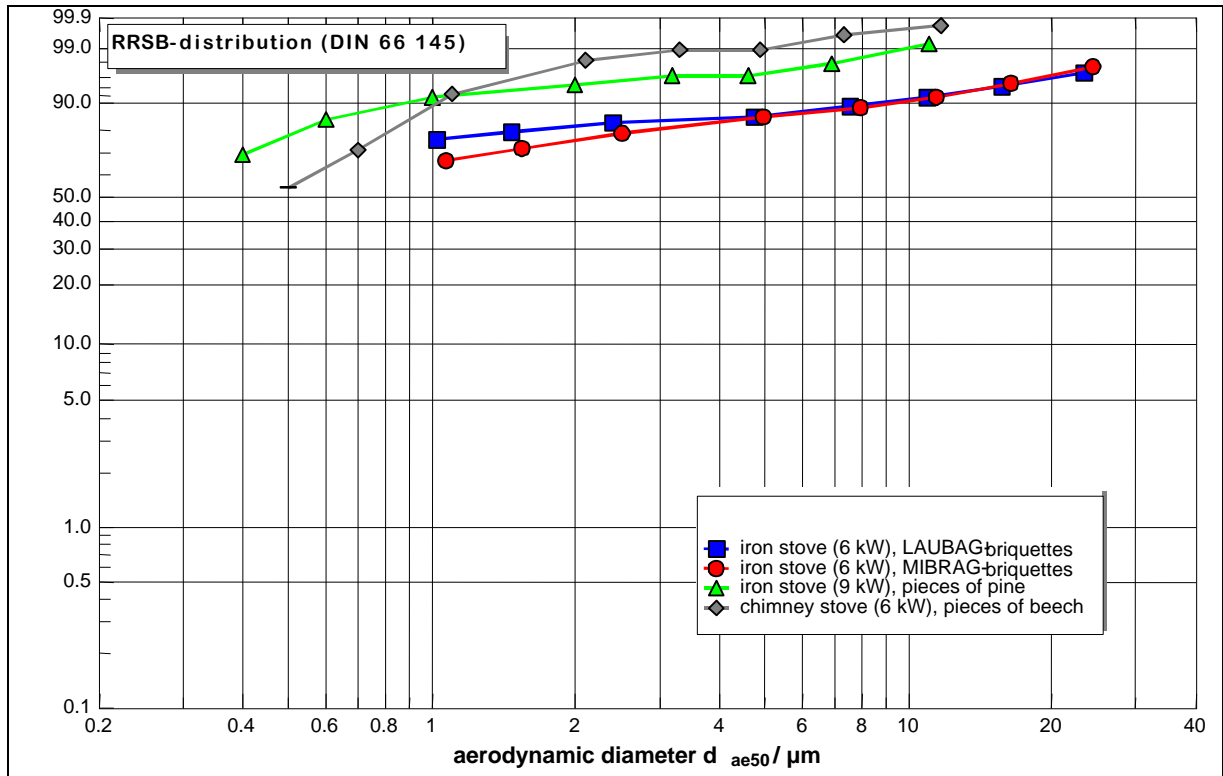

Figure 2: Small Scale Firing Units

In the following figure 3 the determined particle size distribution of the dust in a 150 kW wood combustion, using different fuel, is shown.

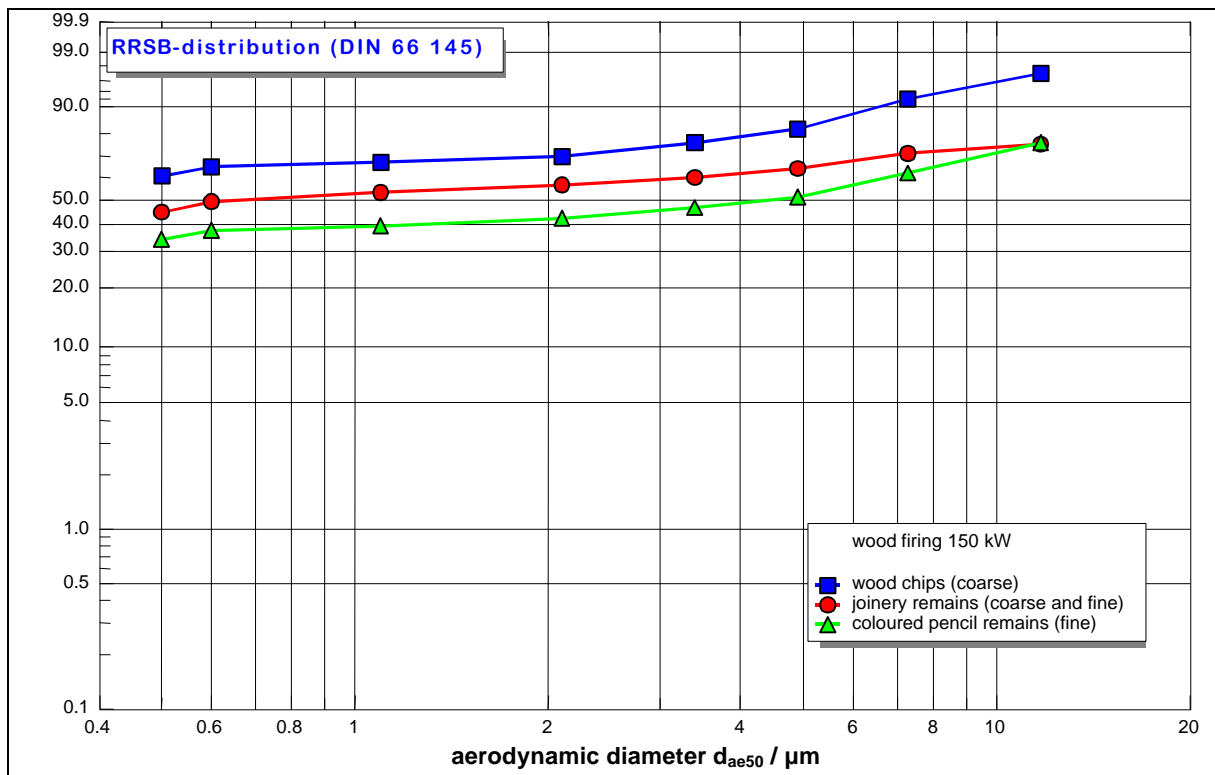

Figure 3: Wood Firing Installation using different Biomass Fuel

3.2 Analysis of technology-specific relationships between the proportions of PM 10, PM 2.5 or PM 1.0 in the emitted dust

In order to find out general trends, all average results of the examined operation conditions were arranged accord-

ing to the size of PM 2.5-proportions independently of the possible factors of influence such as firing technology, output, kinds of fuel as well as exhaust gas cleaning (figure 4).

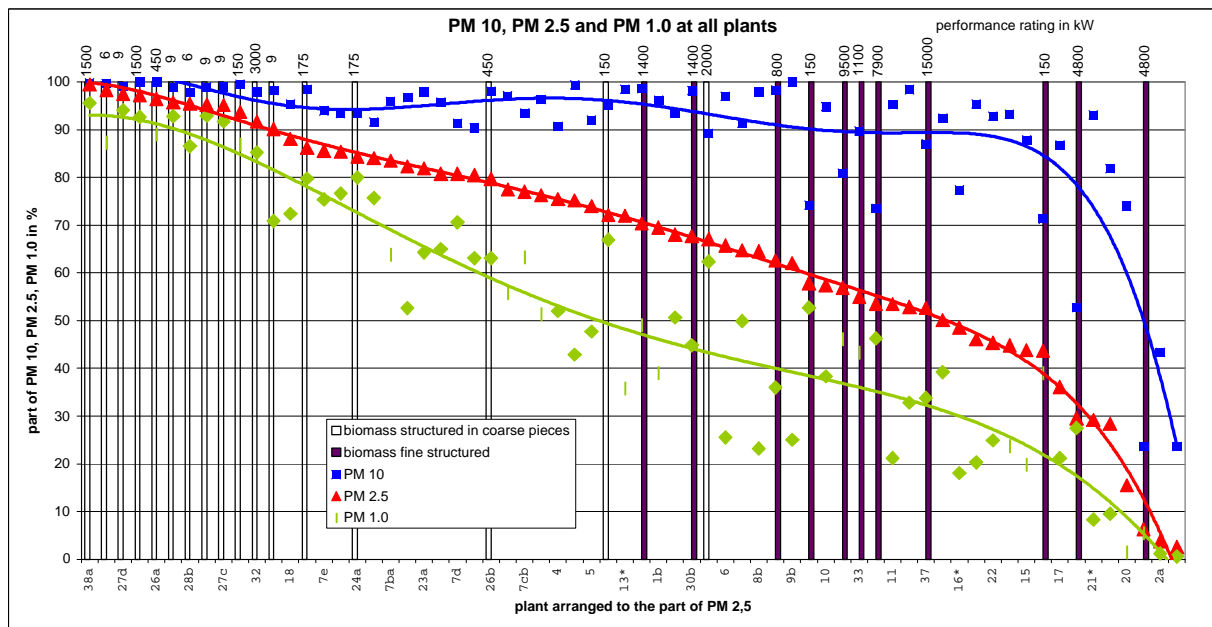

Figure 4: Average Proportion of PM 10, PM 2.5 and PM 1.0 at all Examined Plants, Biomass Combustion is Marked

It is obvious that the largest part of the examined installations emits dust with a high proportion of fine particles (more than 90 % particle size < 10 µm). Approximately 75 % of the examined installations have at least an average PM 10-proportion > 90 %. Considerably smaller PM 10 - and as a rule smaller PM 2.5 - and PM 1.0 - proportions were found at a grate cooler in the cement industry (two measuring periods) with fabric filter, at a sand reprocessing system with electrical gas cleaning and at other installations.

A dependency of the PM 10-emission concentration on the kind of the used exhaust-gas cleaning system could not be determined. Thus also smaller PM 10-proportions were determined partly considerably below 90 % at systems with fabric filter (e.g. grate cooler). On the other hand, domestic stoves for solid fuel without separators contained very high amounts of fine particles in the exhaust gas.

It must be assumed that other technology-related influences on the amount of the fine particle proportions in the

exhaust gas are more dominating than the influence by the kind of the exhaust gas cleaning technique. The technical status of the dedusting or the separation function of the dedusting unit play probably an important role in dependence on the raw gas particle size distribution. But this was not further dealt with.

If the proportions of PM 1.0 and PM 10 are analysed similarly to those of PM 2.5 you can see that they essentially follow the trend of the PM 2.5-proportion. But in many cases there are considerable deviations from this trend line. It was generally noticed that deviations from the trend to smaller PM 2.5 and PM 1.0-proportions were found; that means to a coarser particle size distribution in the emitted dust when firing fuel in pulverized or in liquid form. That concerns such fuel like wood chippings, saw chippings, pencil residues, raw brown coal, dried brown coal (approx. 1 mm grain size) or added limestone for the desulphurization of the exhaust gases. This is also right for the examined heavy fuel oil firings.

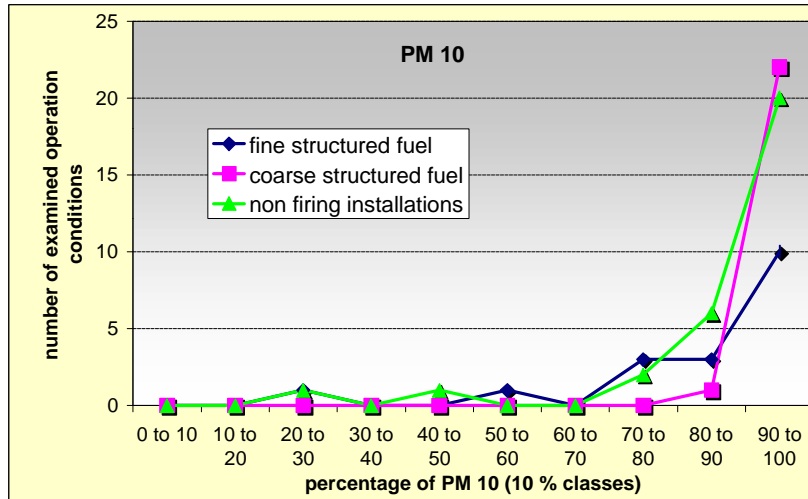

Figure 5: Number of Examined Operation Conditions versus Proportion of PM 10

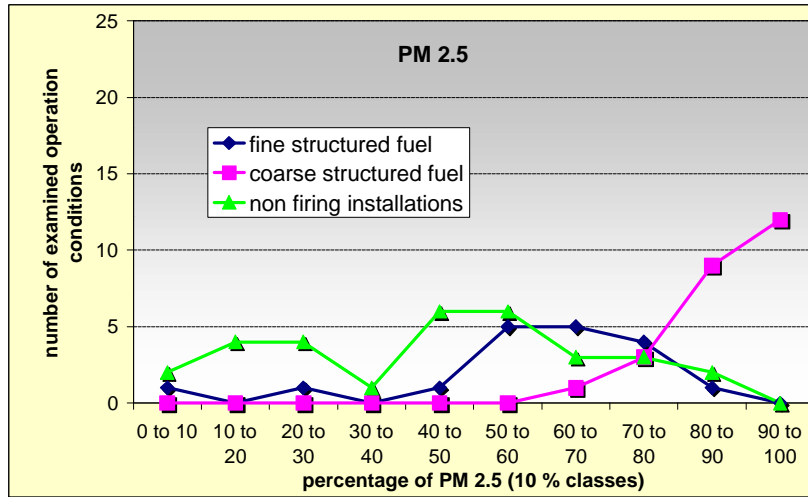

Figure 6: Number of Examined Operation Conditions versus Proportion of PM 2.5

Clearly lower proportions of PM 1.0, PM 2.5 and partly of PM 10 were found at firing installations using fine structured fuel than at firing installations using fuel structured in coarse pieces. At the first mentioned installations either an almost complete combustion of the fuel particles took place or it came to an agglomeration of fine particles in

the cooling process of waste gas. The geometrical structure of the fuel and the associated quality of the complete combustion are obviously essential for the amount of the proportion from fine to ultra fine particles in the exhaust gas.

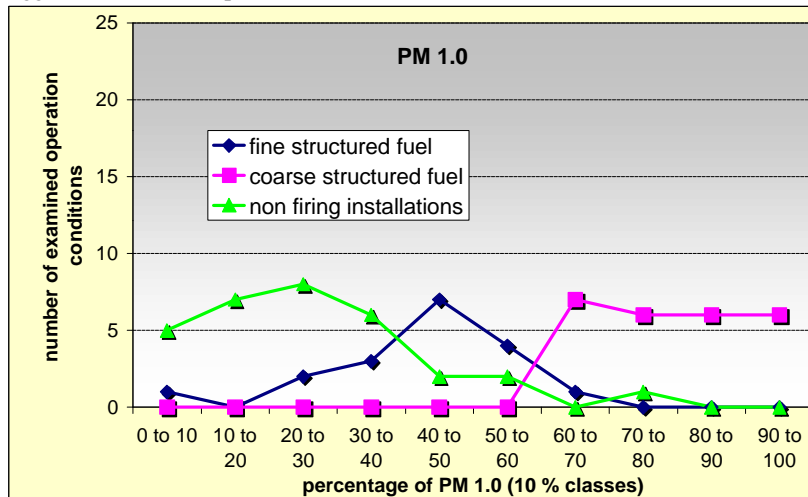

Figure 7: Number of Examined Operation Conditions versus Proportion of PM 1.0

4. CONCLUSIONS

The results show that there is a high amount of fine particles in the waste gases, dependent on the kind of industrial plants and on the used fuel. Approximately 75 % of the examined installations have at least an average PM 10-proportion > 90 %. Higher proportions of PM 2.5 and PM 1.0 were found at firing installations with coarser structured solid fuel in contrary to installations using finer structured pulverized fuel. This is also the case for biomass combustion.

ACKNOWLEDGEMENTS

The authors thank all involved co-workers of the Bayerisches Landesamt für Umweltschutz, the Sächsisches Landesamt für Umwelt und Geologie and the Universität Stuttgart. Also thanks to all co-workers of the Landesamt für Umweltschutz Sachsen-Anhalt who have taken part in the investigations, in particular Mr. Pohle, Mr. Maiwald, Mr. Lux and Mr. Reifert of the department "Emission and Immission Monitoring" for the sampling and for the analyses as well as Dr. Schumann, Dr. Jacob, Dr. Bärwald, Mrs. Lange and Mrs. Voigt of the department "Air Analytics".

REFERENCES

- [1] Richtlinie 1999/30/EG des Rates vom 22. April 1999 über Grenzwerte für Schwefeldioxid, Stickstoffoxide, Partikel und Blei in der Luft. ABl. Nr. L163, 29.06.1999, p.41
- [2] Feinstaubemissionsuntersuchungen in Sachsen-Anhalt, PM 10-, PM 2.5- und PM 1.0-Emissionen aus Industrie und Hausbrand, Berichte des Landesamtes für Umweltschutz Sachsen-Anhalt, Sonderheft 1/2001
- [3] Bayerisches Landesamt für Umweltschutz, Messberichte des Programms „Ermittlung von Korngrößenverteilung im Abgas verschiedener Emittenten“, Unpublished
- [4] Feinstaubuntersuchungen an Holzfeuerungen. Universität Stuttgart, Institut für Verfahrenstechnik und Dampfkesselwesen, Bericht Nr. 44-1999
- [5] Sächsisches Landesamt für Umwelt und Geologie, Messberichte, Unpublished
- [6] Ehrlich, Chr., Noll, G., Kalkoff, W.-D., Messtechnische Ermittlung von PM 10- und PM 2.5-Emissionen aus Industrieanlagen und Hausbrandfeuerstätten. Neuere Entwicklungen bei der Messung und Beurteilung der Luftqualität, Deutschland, Heidelberg, 1999, VDI-Verlag Düsseldorf, VDI-Berichte: Nr. 1443, pp. 117-129
- [7] VDI 2066 Bl. 5 Messen von Partikeln. Staubmessung in strömenden Gasen, Fraktionierende Staubmessung nach dem Impaktionsverfahren – Kaskadenimpaktor
- [8] VDI 2066 Bl. 1 Messen von Partikeln. Staubmessung in strömenden Gasen, Gravimetrische Bestimmung der Staubbelastung, Übersicht
- [9] VDI 3868 Bl. 1 Messen der Gesamtemission von Metallen, Halbmetallen und ihren Verbindungen, Manuelle Messung in strömenden, emittierten Gasen, Probenahmesystem für partikelgebundene und filtergängige Stoffe
- [10] VDI 2268 Bl. 1 Stoffbestimmung an Partikeln, Bestimmung der Elemente Ba, Ca, Cd, Co, Cr, Cu, Ni, Pb, Sr, Zn in emittierten Stäuben mittels atomspektrometrischer Methoden
- [11] DIN EN 45001 Allgemeine Kriterien zum Betreiben von Prüflaboratorien
- [12] Landesamt für Umweltschutz Sachsen-Anhalt Halle/Saale, Emissionsermittlungs-Berichte 01-97, 06-98, 07-98, 08-98, 10-98, 01-99, 02-99, 03-99, 01-00, 04-99, 05-00, Unpublished
- [13] Ehrlich, Chr., Noll, G., Kalkoff, W.-D., Emissionsuntersuchungen von PM 10, PM 2.5 und PM 1.0 an Industrieanlagen und Hausbrandfeuerstätten, Zeitschrift Immissionsschutz, Berlin, 4 (2000), pp. 141 – 148
- [14] Lützke, K., Muhr, W., Erprobung von Emissionsmessverfahren zur Feststellung von Korngrößenfraktionen, UBA Forschungsbericht 81-10402121, Oktober 1981

INFLUENCES ON AEROSOL FORMATION IN AN AUTOMATIC WOOD FURNACE

M. Oser¹, T. Nussbaumer¹, B. Schweizer², M. Mohr³, R. Figi³

¹Verenum Research, Langmauerstrasse 109, CH – 8006 Zurich, Switzerland
phone +41 (0)1 364 14 12, fax +41 (0)1 364 14 12, email verenum@access.ch

²Tiba-Müller AG, Bechburgerstrasse, CH – 4710 Balsthal, Switzerland

³Swiss Federal Laboratories for Materials Testing and Research, EMPA, CH – 8600 Dübendorf, Switzerland

ABSTRACT: In Switzerland, automatic wood furnaces in the size range between 200 kW and 2 MW are often used for heat production in industry and for district heating. These types of furnaces are capable to reach almost complete combustion conditions if operated properly and with suitable fuel. For particulate removal, furnaces in this size range are equipped with multi cyclones. Due to economic reasons, filters are not applied except if contaminated wood is burnt. Since the main part (up to more than 90 % by mass) of the particulate matter under good combustion conditions is smaller than 1 µm, multi cyclones have a poor separation efficiency. As a result, typical particulate concentrations of 100 – 150 mg/Nm³ at 13 vol-% O₂ are found in the flue gas. To reduce the environmental impact of such furnaces, primary measures for particulate reduction are of interest.

In the present project, the influences of operation, design parameters, and fuel characteristics on particulate emissions in an automatic wood furnace are investigated. The particulate emissions are characterised by the particle mass, the mass size distribution (by Anderson impactor), the number size distribution (by ELPI and SMPS), and the chemical composition. Special focus is given on submicron particles. Further, quasi-complete combustion (CO < 50 mg/Nm³ at 13 vol-% O₂) is achieved in a wide range of operation. Since incomplete combustion can be avoided in state-of-the art furnaces, measurements are performed solely if quasi-complete combustion is achieved. Since organic components in the particulates are of interest for the judgment of the combustion process and potential health effects, organic and inorganic carbon is analysed.

The results show, that the content of fines in the fuel has no significant influence on the particulate emissions, if the furnace is operated at similar combustion conditions. Further, also the excess air has only a slight influence if all other combustion parameters are similar (i.e. the difference to standard operation is less than a factor of 1.2 for the particle mass), with a tendency to higher particle number at slightly lower mean size and smaller particle mass at high excess air. Both results are in contradiction to practical experiences, where fines in the fuel or operation at low excess air often lead to high particulate emissions. It is assumed, that the apparent influences found in practise are indirect: High fines in practise or large variations in excess air often lead to unfavourable combustion conditions. This may result in significant influences on formation mechanisms and high concentrations of unburnt particles, while the test furnace achieves quasi-complete combustion in a wide range.

Keywords: Particulate emissions, excess air, fuel size, fines, temperature, automatic wood furnace.

1. INTRODUCTION

Wood furnaces exhibit higher emissions of particulate matter (PM) than oil and gas furnaces. In a study by the Swiss Federal Office of Environment (BUWAL) published in 2000 [1], the average particulate emissions of automatic wood furnaces in Switzerland are estimated at 109 kg/TJ useful energy in comparison to 0.11 kg/TJ for oil and 0.10 kg/TJ for gas furnaces. Hence a significant reduction of particulate emissions is needed to reduce the environmental impact of wood furnaces. Automatic wood furnaces with heat outputs between 200 kW and 2 MW are most common in Switzerland in industry and for district heating. Such plants are equipped with multi cyclones and have typically even higher particulate emissions than well operated and designed log wood boilers. The application of fabric filters or electric precipitators is limited in this size range due to economic

reasons. Hence there is a great interest in primary measures for the reduction of particulate emissions from automatic wood furnaces to improve their environmental assessment.

Although the mass concentration is used nowadays for the definition of emission limit values, the relevance of particulates is influenced by size, chemical composition, physical properties, morphology, and transport and reaction phenomena in the atmosphere.

It is a precondition for low particle emissions that the combustion is quasi-complete and all carbon is completely oxidised. The CO-concentration in the flue gas is often used as indicator for the completeness of the combustion. However the carbon content in the ash and the particulate emissions also has to be considered. In the present investigation, a quasi-complete combustion of the gases is assumed if the CO concentration in the flue gas is below 50 mg/Nm³ at 13 vol.-% O₂.

Also if the combustion is quasi-complete, large differences in particulate concentrations in the flue gas can be found in automatic wood furnaces. Hence the following questions are of interest:

- Which are the main factors for the aerosol formation in automatic wood furnaces?
- What are the main influences of operation and design parameters (beside quasi-complete combustion) to reduce the particulate emissions of automatic wood furnaces?

The present project aims to answer these questions by a systematic investigation of influence parameters in a test furnace. The automatic test furnace enables combustion conditions as they are typical in conventional under stoker furnaces. In addition, operation parameters which are correlated in practice can be varied independently in the test furnace (temperature, fines, and others). The project is carried out in cooperation between Verenum, Tiba-Müller AG and the Swiss Federal Laboratories for Materials Testing and Research (EMPA). To enable an assessment of the influences on the particulate emissions, mass, size distribution, composition and morphology of the particulates are investigated.

2. THEORY

2.1 Types of particulates

Particulates are formed by incomplete combustion and by complete combustion. Table 1 gives an overview on the main types of particulates found in wood combustion.

2.2 The process of wood combustion

Wood combustion is a complex process with homogenous and heterogenous reactions. To reduce the particle emissions it is of interest to identify the relevant process

steps for particle formation. Figure 1 shows the main reaction mechanisms of aerosol formation during wood combustion. The process of wood combustion is described by 9 process steps:

1. Drying of the wet wood
2. Decomposition of the wood
3. Gasification
4. Oxidation of the combustible gas
5. Synthesis
6. Oxidation of unburned particles
7. Nucleation
8. Coagulation of the nucleation germs
9. Growth of soot and organic carbon particles by agglomeration and adsorption.

Table 1: Formation mechanism and chemical composition of particulates from wood combustion [2].

Particles formed by incomplete combustion	Particles also formed by complete combustion
<ul style="list-style-type: none"> • Elementary carbon (Charcoal) • Organic carbon in the form of unburned components of wood • Organic carbon in the form of tar (high-order, formed by pyrolysis) 	<ul style="list-style-type: none"> • Mineral components of wood • Components adhering to the wood (sand, soil) • Crystalline compounds, salts (chlorides, sulphates, carbonates, oxides,)
<ul style="list-style-type: none"> • Organic carbon in the form of soot (formed in the flame) 	<ul style="list-style-type: none"> • Metallic oxides (Al_2O_3, Fe_2O_3)

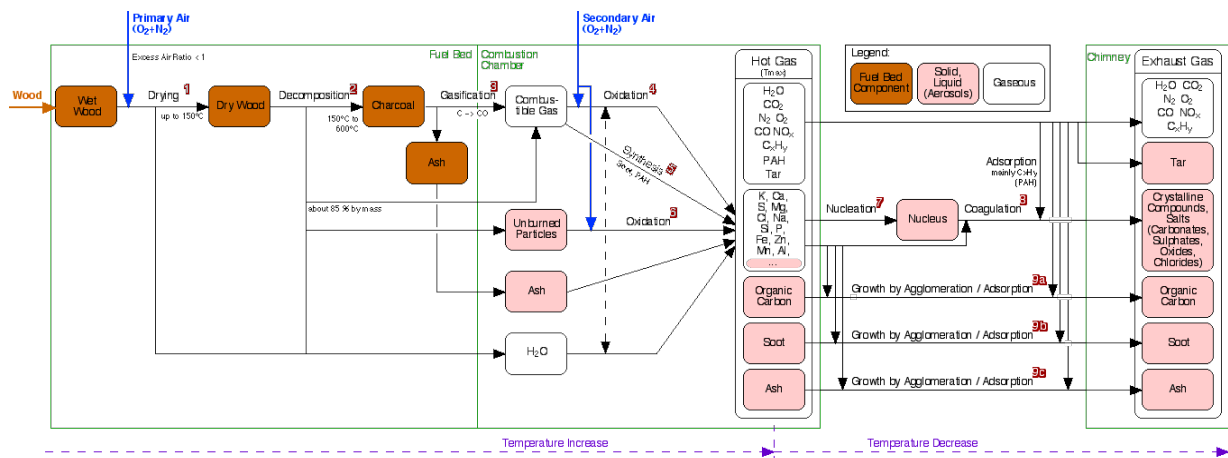

Figure 1: Process of wood combustion focussed on aerosol formation divided in 10 main process steps.

3. EXPERIMENTAL

3.1 Test equipment

The test equipment is based on an automatic under stoker furnace with a rated output of 120 kW (figure 3). The test equipment is designed to enable an almost independent variation of the interesting parameters. For this purpose, additional components are utilised, i.e.: flue gas recirculation, variable water cooling of the fuel bed, preheating of primary air, water injection in the com-

bustion chamber. Further the fines in the fuel can be varied. For this purpose, fines < 3 mm are separated from the fuel before feeding into the furnace (figure 2). Coarse fuel chips > 3 mm and fines < 3 mm can be feeded independently to a well defined mixture before entering the furnace. This enables a continuous variation of fines for all investigated fuels between 0 % and up to 100 %. To investigate particulate emissions without influence of separation processes, the test furnace is operated without cyclone.

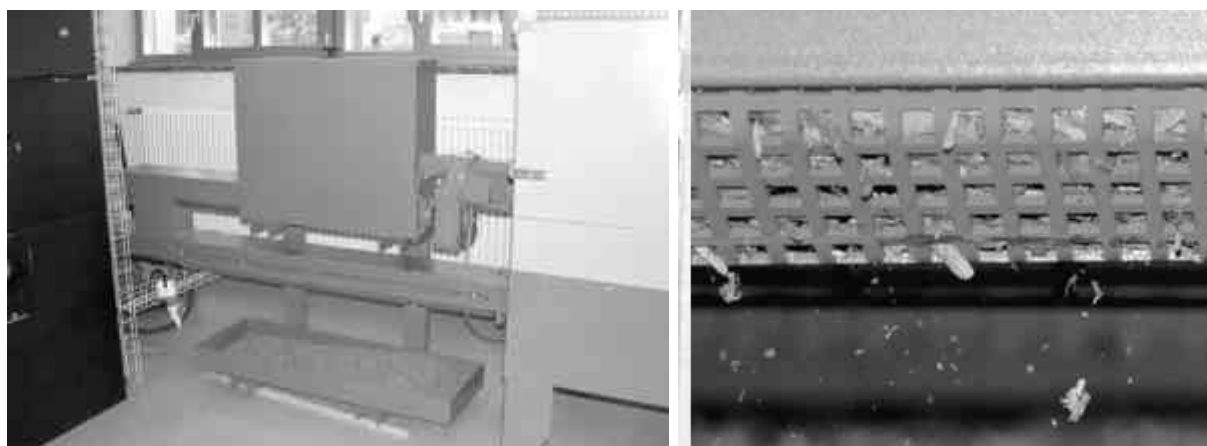

Figure 2: The continuous screening of the fines of wood is realised with a punched metal sheet positioned under the screw-conveyor (right). The fines are falling into a tub (left). These fines can be put in a second tub which is positioned over a second screw-conveyor (left). According to requirements the fines can be added with the second screw-conveyor to the wood in the first screw-conveyor.

3.2 Measuring programme

To enable well defined operation, the furnace is operated at stationary conditions for more than 4 hours before sampling of particulate emissions is performed. The adjustment of the furnace starts by a reference operation which is repeated periodically. Table 2 shows the parameters during reference operation.

Table 2: Parameters for reference operation.

Fuel type wood	wood chips of beech
Water content	40 %
Fines of wood < 3 mm	1.3 mass-%
Externally procured parts, bark parts and fines	Slight
Heating output	75 % of the rated output
Depression in the combustion chamber	40 Pa
Total excess air ratio	1.8
Part of secondary air	35 %

All additional components are not used during reference operations, i.e. flue gas recirculation, water cooling of the

fuel bed, preheating of the primary air, water injection, addition of fines.

3.3 Measurement techniques

For characterisation of the particulates in the flue gas several measurements techniques were used simultaneously:

- Plan filters for the total mass concentration and for sampling for the chemical analysis
- Electric Low Pressure Impactor (ELPI) for the aerodynamic size distribution
- Scanning Mobility Particle Sizer (SMPS) for the submicron number size distribution
- Andersen impactor for the mass size distribution.

By the chemical particle analysis the mass content of the following elements are analysed:

C, H, Cl, P, K, S, Na, Ca, Mg, Fe, Al, Mn and Zn

Moreover, the total organic carbon (TOC) and the inorganic carbon (IC) were differentiated. The TOC are determined with a Shimadzu TOC-analyser SSM 5000A in three steps:

- Measuring the total carbon (TC) by NDIR-detection of CO₂, after a catalytic (V₂O₅) combustion in an oxygen medium by 980°C.
- Measuring the inorganic carbon (IC) by NDIR-detection of CO₂ after expulsion with phosphoric acid by 200°C.
- TOC is calculated as difference between TC and IC.

For analysing the element C and H, CO₂ and H₂O is measured by IR-detection after catalytic combustion by 1000°C. Chloride is analysed with ion chromatography after an extraction with hot water. The other elements were measured with ICP-OES after open disintegration with hydrochloric acid. The chemical structure is analysed with x-ray analysis (XRD).

The concentration of CO₂, O₂, CO, NO_x, and SO₂ in the flue gas are continuously analysed with IR analysers (Horiba PS-200) and the heating output with a heat counter.



Figure 3: Test equipment with the under stoker wood furnace, samplin in the flue gas, and particle measurement systems with data acquisition.

4. RESULTS

4.1 Quasi-complete combustion, reference operation

By suitable furnace parameters, the CO-concentrations are noticeable lower than 100 mg/Nm³ by 13 Vol.-% O₂ with 30 minute average values far below 50 mg/Nm³. Figure 4 shows typical CO-concentrations during reference operation.

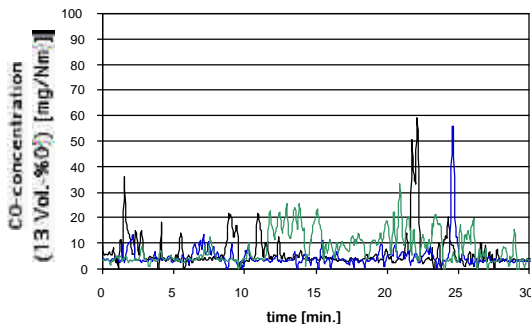

Figure 4: Typical CO-concentrations in the flue gas of the furnace (three different operations).

A quasi-complete combustion is also achieved for particulate emissions as is shown by the chemical composition of the particles: During reference operation, the content of organic carbon in the particulates is around 1.1 mass-% (table 3, excess air ratio 1.8).

The mass size distribution of the particles in the flue gas is bimodal with a primary peak under 0.4 μm and a smaller peak at about 10 μm (figure 5).

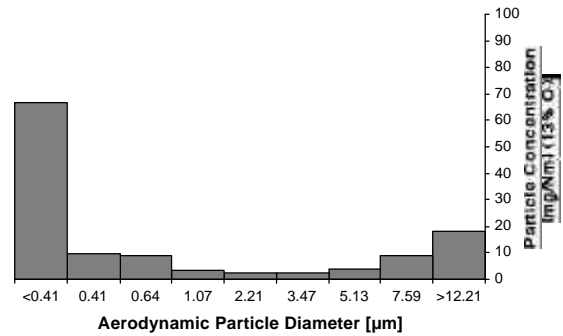

Figure 5: Mass size distribution of the particles in the flue gas by reference operation measured with an Andersen impactor.

4.2 Variation of the excess air

The influence of the total excess air ratio (with constant percentage of secondary air) to the particle mass concentration is shown in figure 6 and to the particle size distribution and concentration in figure 7 (SMPS) and figure 8 (ELPI).

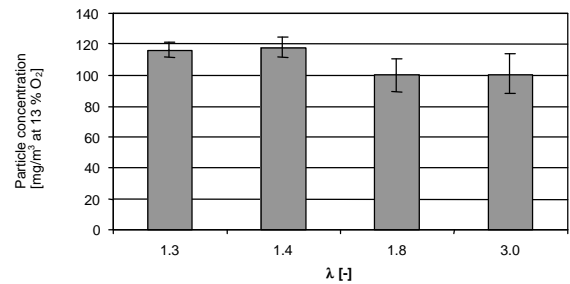

Figure 6: Total particle concentrations in the flue gas of the automatic wood furnace as function of the total excess air ratio (constant percentage of secondary air 35%, heating output 75% of the nominal heating output).

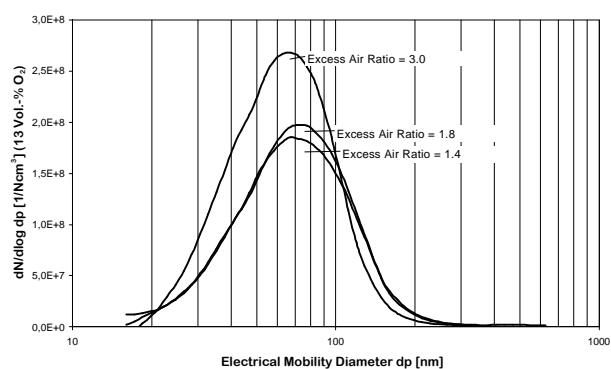

Figure 7: Influence of the total excess air ratio λ to the formation of submicron particles (constant percentage of secondary air 35%, heating output 75% of the nominal heating output).

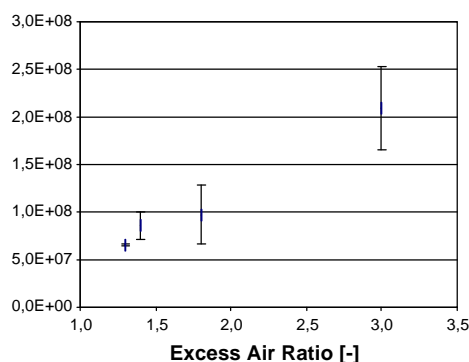

Figure 8: Influence of the total excess air ratio λ to the number concentration in the flue gas measured with ELPI (constant percentage of secondary air 35%, heating output 75% of the nominal heating output).

The increase of the total excess air λ from 1.4 to 3.0 leads to a decrease of the particle mass concentration of 14% (figure 6) and an increase of the particle number concentration of about 30% (figure 7). The most frequent diameter is always between 60 nm and 80 nm and with growing total excess air it tends to be smaller (figure 7). It is assumed that the investigated influence of the excess air is a result of diminished agglomeration due to higher dilution with increasing excess air.

The elemental composition of the particles in the flue gas at an excess air of 1.4 and 1.8 is showed in table 3. The content of organic carbon is higher at $\lambda=1.4$ than at $\lambda=1.8$, which is attributed to local oxygen shortage at low excess air, while the temperature at low excess air is higher. However the organic carbon content from incomplete combustion is still low at $\lambda=1.4$.

The residual is attributed mainly to O. However certain amounts of other elements such as Si and trace elements can also be part of the rest.

Table 3: Elemental composition of particulate emissions for different excess air ratios.

Elements	Part in mass-%	
	Excess air 1.4	Excess air 1.8
C	7.9	6.7
TOC	2.4	1.2
TIC	5.5	5.7
K	53	32.5
Ca	3	6
S	9.2	4.8
H	1.7	2.7
Mg	0.23	0.72
Cl	–	0.49
Na	0.68	0.27
P	0.10	0.18
Fe	0.051	0.083
Zn	0.120	0.061
Mn	0.048	0.058
Al	0.022	0.055
Residual (O, other elements)	24.0	45.4

4.3 Variation of the fines in the fuel

In practise, high particulate emissions are often found if fuel with high content of fines is burned, while wood chips with low content of fines are favourable to burn. Hence the influence of fines in the fuel under well defined conditions was investigated.

The particle concentration in the flue gas depending on the fines in the fuel (i.e. fuel particles < 3 mm) is shown in figure 10. In comparison to the reference operation with 1.3 mass-% of fines even a very high part of fines up to 27.6 mass-% leads to an insignificant increase of the particle concentration from 100 mg/Nm³ to approx. 110 mg/Nm³. There is also only a slight influence on the elemental composition of the particles (table 4).

This result is in contradiction to experiences from automatic wood furnaces in practise, where wood fuels with high fines often lead to excessively high particulate emissions. Since a direct correlation between fuel size and particle size is not expected, it is assumed, that the content of fines in the fuel does not directly lead to increased particulate concentrations. However it may lead to unfavourable combustion conditions in practise due to an uneven air distribution in the fuel bed. As a result, higher particulate emissions are found due to incomplete combustion and local shortage of oxygen or – if the combustion air is increased to maintain air flow – due to very high excess air.

In comparison, the test furnace can be operated at good combustion conditions also if the fuel has a high content of fines. Thanks to similar combustion conditions as with low fines, there is no significant influence on particulate emissions as expected.

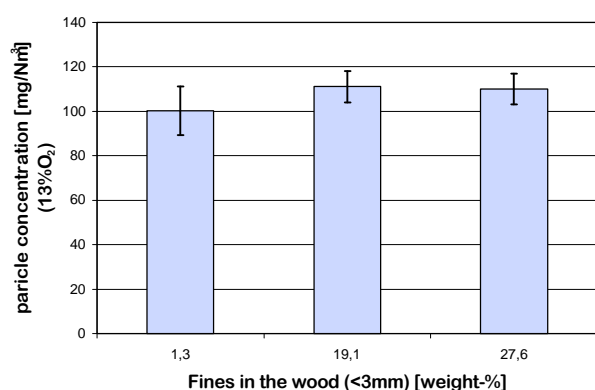

Figure 10: Particle concentration in the flue gas depending on the fines (<3mm) in the fuel (constant percentage of secondary air of 35%, a heating output 75% of the rated output) at an excess air between 1.7 and 1.8 (no of measurements: 18/4/6 for fine-grained parts of 1.3/19.1/27.6 mass-%).

Table 4: Elemental composition of the particle in the flue gas at two different fine-grained parts of wood (<3mm).

Element	Part in mass-%	
	Fines < 3 mm: 1.3 mass-%	Fines < 3 mm: 19.1 mass-%
C	6.7	6.0
TOC	1.2	1.0
TIC	5.7	5.0
K	32.5	29
Ca	6	8.7
S	4.8	5.8
H	2.7	0.87
Mg	0.72	0.97
Cl	0.49	0.37
Na	0.27	0.25
P	0.18	0.25
Fe	0.083	0.14
Zn	0.061	0.088
Mn	0.058	0.055
Al	0.055	0.1
Residual (O, Si)	45.4	47.4

5. CONCLUSIONS

In the present project, the influences of operation and design parameters on particulate emissions in an automatic wood furnace are investigated.

The results in a properly designed under stoker furnace show that the fraction of organic carbon in the particulate emissions is < 3 wt.-% for quasi complete combustion with CO concentrations < 50 mg/Nm³ at 13 vol.-% O₂. Since such a burn out quality can be achieved in state-of-the-art furnaces, it is assumed as standard value for the implementation of new furnaces. Hence the present investigation are performed under quasi complete combustion and the aim is to deduce how anorganic particulates can be influenced. The experiments under these conditions allowed the following variations:

- Combustion temperature from 650 °C to 1000 °C
- Excess air ratio from 1.4 to 1.8
- Content of fines < 3 mm in the fuel from 1.3 % to 27.6 %.

These quite broad variations resulted only in small changes of particle mass and particle size distribution in the flue gas, i.e. a factor of around 1.2 for the particle mass and mode of the size distribution, and a factor smaller than 2 for the total particle number. Although aerosol formation can be influenced by the investigated parameters, the influences on the non-organic fraction of particulates is limited. Since the small influences found here are in contradiction to experiences in practise. It is assumed that indirect influences are often found, e.g. high fines in the fuel may result in unfavourable combustion condition in practise. Hence an optimisation of the combustion parameters investigated so far does not enable a significant reduction of particulate emissions (e.g. safely < 50 mg/Nm³ at 13 vol.-% O₂ for all fuels). However additional influences and primary measures such as flue gas recirculation and new applications of staged combustion are investigated in the ongoing project.

ACKNOWLEDGMENTS

The present investigation is funded by the Swiss Federal Office of Energy and the Swiss Federal Office of Environment, Landscape, and Forestry, which is gratefully acknowledged.

REFERENCES

- [1] BUWAL (Bundesamt für Umwelt, Wald und Landschaft), Kessler F. and Frischknecht R.: *Heizenergie aus Heizöl, Erdgas oder Holz*, Schriftenreihe Umwelt Nr. 315, Bern 2000
- [2] Oser, M., Nussbaumer, Th., Schweizer, B., Mohr, M., und Figi, R.: *Untersuchung der Einflüsse auf die Partikelemissionen in einer Unterschubfeuerung*. 6. Holzenergie-Symposium, Zürich, 20.10.2000.

INVESTIGATION OF AEROSOL FORMATION AND CLEANING EFFICIENCY IN COMMERCIALY OPERATED BIOMASS FIRED BOILERS

L Lillieblad¹, M Strand¹, J Pagels², A Szpila², E Swietlicki³, M Sanati¹, M Bohgard²

¹ Växjö University, Division of Bioenergy, S-351 97 Växjö Sweden
phone +461 (0)470 708996, fax +46 (0)470 708756, email lena.lillieblad@ibp.vxu.se

² Lund University, Division of Ergonomics and Aerosol Technology, Box 118, S-221 00 Lund, Sweden

³ Lund University, Division of Nuclear Physics, Box 118, S-221 00 Lund Sweden (3)

ABSTRACT: In Sweden biofuels and peat contribute to about 15% of the total energy supply. These biofuels are mainly from the forest and the forest industry. One popular way to utilise this resource is as fuel in small district heating plants (<10 MW). These plants have usually grate boilers and multicyclones are often the only flue gas cleaning equipment. The particle emission is usually in the range of 100 – 200 mg/m³ (101.3 kPa and 0 °C).

The fine particle fraction has been investigated at small district heating plants with differential mobility analyser (DMA, TSI SMPS 3934), time of flight instrument (TSI APS 3320) and low pressure cascade impactor (LPI, Dekati). Chemical analyses of the collected particles have been made by PIXE (Particle Induced X-ray Emission). The hygroscopic properties of the submicrometer particles were studied using H-TDMA (Hygroscopic Tandem Differential Mobility Analyser).

Three different biofuels, moist forest residues, dry industrial wood waste and pellets, were fired in three different grate boilers. The submicrometer particle emissions after the multicyclones were studied. Potassium, chlorine and sulphur dominate the elemental composition of the submicrometer particles according to PIXE for all the three different fuels and test locations.

The particle properties and concentrations were also studied after a biofuel fired grate boiler equipped with multicyclone followed by an electrostatic precipitator (ESP) and a flue gas condenser.

The hygroscopic properties of the particles are of importance for the behaviour in the atmosphere. The finest particle fraction (< 300 nm) was investigated with H-TDMA and showed if classified on the same basis as an ambient aerosol a so-called more-hygroscopic behaviour.

Keywords: Biofuel, submicrometer particles, DMA, impactor, PIXE, H-TDMA

1. BACKGROUND

In Sweden biofuels including peat is one of the major energy sources contributing to about 15% of the total energy supply [1]. More than 50% of the biofuels are used in the industrial sector as black liquor in the pulp industry and by-products in the pulp industry and saw mills.

More than 25% is fired in district heating plants and the remaining part is used for electricity and residential heating.

Kronoberg is a county in the southeastern part of Sweden with a population of about 180 000 inhabitants. Kronoberg has a good access to forest residues and by-products from the wood industry. In this area there are about twenty small district heating plants (<10 MW) in operation or in construction with a total capacity of about 110 MW. These boilers are often of moving grate type fired with forest residues, sawdust or other by-products from the local wood industry. Some installations are fired with refined fuels like pellets.

These plants have often a requirement on particle emission in the range of 150 mg/m³ (101.3 kPa and 0 °C). This limit can often be met with multicyclones only.

There is also a large circulating fluidised bed boiler in this area. This boiler has a capacity of 104 MW including 38 MW electricity and 66 MW heat. This plant has an efficient flue gas cleaning system including SCR (selective catalytic reduction) for NO_x removal, ESP (electrostatic precipitator) for dust removal and flue gas condenser for heat production. Lime can be added to the bed material if a sulphur containing fuel like peat is used. This boiler gives very low emissions of particles and gaseous pollutants.

Aerosol formation and aerosol characterisation from the small district heating plants is studied as a part of a larger Swedish project with the objective to identify the possible negative effects from biomass combustion predominantly from these plants and residential heating.

Biomass combustion has been identified as a significant source to the particle mass concentration in ambient air.

2. METHODS

Measurements were made after three boilers firing three different biofuels. All three boilers were of grate type and equipped with multicyclones for particle collection. The nominal boiler capacities were in the range 0.8-1.5 MW.

The three different fuels were moist forest residues, dry industrial wood waste and pellets.

The flue gas was sampled between the multicyclone and the stack. The sampled flue gas was diluted. A pre-cyclone with a cut-off particle diameter of 2.5 μm (d_{50}) was used to collect coarse particles. The number weighted particle size distribution was measured with a differential mobility analyser (DMA, TSI SMPS 3934) followed by a condensation particle counter (CPC) covering particle sizes up to 800 nm. The coarser particle fraction was measured with a time of flight instrument (TSI APS 3320). Both instruments provide near real-time measurements. The mass weighted particle size distribution was measured with a low pressure impactor (LPI) from Dekati. The test set-up can be seen in figure 1.

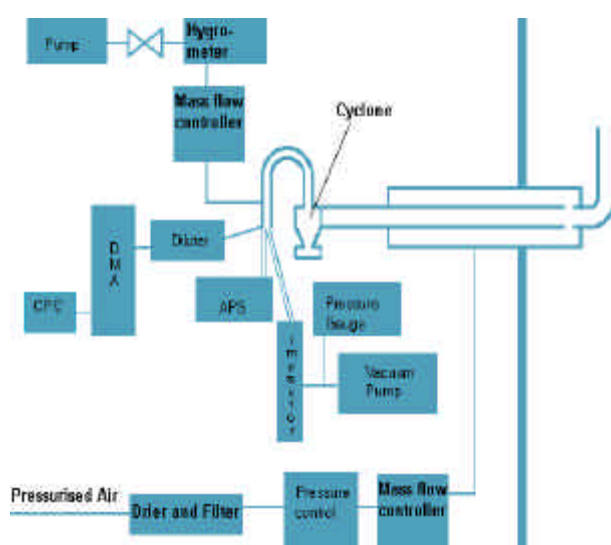

Figure 1. Test set-up with DMA, APS and impactor (LPI)

A similar test set-up was used to study particle properties and concentrations in a plant with a more advanced particle removal system. The pre-cyclone cut-off particle diameter was 10 μm (d_{50}) instead of 2.5 μm . The plant has a capacity of 6 MW and is fired with moist forest residues. The particle collection system consists of a multicyclone followed by a one-field ESP and a flue gas condenser. Measurements were made before and after the ESP and after the flue gas condenser.

The low pressure impactor tests were made both with polycarbonate collection substrates for chemical analyses and with aluminium collection substrates for accurate mass determination.

The chemical analyses of the collected particles were made by PIXE (Particle Induced X-ray Emission) for elements with $Z > 12$, i.e. elements heavier than aluminium, for the tests with the three different fuels.

The hygroscopic properties of the emitted submicrometer particles were studied with H-TDMA. The H-TDMA consists of two DMA, two CPC and a humidifier. The first DMA is used to create a monodisperse aerosol from the diluted flue gas. The dry particles are then taken to a humid environment with a relative humidity of 90% and the change in particle diameter was studied in a second

DMA. The hygroscopic growth for particles with dry diameter in the range of 20 to 265 nm was studied at a plant firing moist forest residues.

3. FUEL COMPARISON

The fuel and fuel ash data for the three is summarised in table 1-2.

Table 1: Fuel data. All figures are given as % by weight on dry basis. The ash content is given for an ashing temperature of 575 $^{\circ}\text{C}$.

	Moist forest residue	Dry industrial wood waste	Pellets
Ash	2.1	0.26	0.46
Sulphur	0.04	0.01	0.01
Chlorine	0.026	0.016	0.018

Table 2: Ash analyses given as oxides (ashed at 575 $^{\circ}\text{C}$)

	Moist forest residue	Dry industrial wood waste	Pellets
Na_2O	0.4	0.1	0.7
K_2O	10.3	12.7	12.3
CaO	42.8	29.9	39.1
MgO	5.1	7.9	6.5
Al_2O_3	0.7	0.1	0.5
Fe_2O_3	0.8	0.2	1.3
SiO_2	7.2	0.0	2.3
P_2O_5	6.3	2.0	3.3
TiO_2	0.1	0.0	0.1
SO_3	3.6	31.6	8.6
CO_2	21.3	10.9	21.0
MnO	0.9	3.8	3.5
Total	99.5	99.2	99.2

In the forest residues there is a high content of bark and also some contaminants from the soil giving compared to the other two fuels a relatively high ash content. The content of SiO_2 will also be higher for this type of fuel.

Unfortunately the operating conditions varied significantly between the three different plants. The outdoor temperature directly influences the need for heat and so the boiler loads. The tests at the pellets fired plant were made during two relatively warm days and the boiler load was very low.

The chemical composition of the submicrometer particles was analysed by PIXE.

The PIXE analyses show that potassium, sulphur and chlorine dominate the fine particle fraction. Calcium is a major ash component, but the calcium content in the fine fraction is negligible. The distribution between different components in the submicrometer range as measured by PIXE is given in table 3. This distribution does not include components like carbon, oxygen, sodium and aluminium.

Table 3. Mass distribution of the submicrometer particles as measured by PIXE (% by mass)

	Moist forest residue	Dry industrial wood waste	Pellets
Potassium	58	75	52
Chlorine	19	6	20
Sulphur	17	12	16
Zinc	4	3	10
Cadmium	0.15	0.57	0.51
Lead	0.21	0.05	0.24

The domination of potassium, chlorine and sulphur coincide to a large extent with previous studies made during wood combustion at fluidised bed boilers or grate boilers. [2, 3, 4].

The particle emissions from the two boilers fired with moist forest residues (1.0 MW and 6.0 MW boiler capacity respectively) have been further studied. Some preliminary results regarding the submicrometer particles are given in table 4. Geometric mean particle diameters and particle number concentrations were measured by SMPS. Massmedian aerodynamic particle diameters and particle mass concentrations were measured by LPI. MPS data were converted to a mass weighted particle size distribution and compared with LPI data. An effective particle density of 2-2.5 g/cm³ was found. Chemical analyses of the fuels and the particles (PIXE) will be available soon.

Table 4. Preliminary results regarding the submicrometer particles from two boilers fired with moist forest residues.

Geometric mean diameter (nm)	80-120
Mobility equivalent diameter	
Massmedian aerodynamic diameter (nm)	200-300
Number concentration (particles/cm ³)	2-4*10 ⁷
Mass concentration (mg/m ³ , 101.3 kPa and 0 °C)	25-100

4. CLEANING EFFICIENCY

The dust collection system has to be chosen with respect to the required emission level and the actual operating conditions. For many small grate boilers multicyclones are sufficient to meet the required emissions. The cyclone removes the coarse fraction but does not remove particles with a diameter below a few µm. The emitted particles could locally be a significant source of primary particles to the ambient air.

More stringent particle emission requirements can easily be met with an electrostatic precipitator (ESP). The ESP has usually high particle removal efficiency in the complete particle size range. The removal efficiency has a minimum for particles having an aerodynamic diameter

around 0.2 µm. ESP's are widely used for this type of application in Sweden, when the requirements are more stringent or the multicyclone is unable to meet the requirements.

Fabric filter is an alternative when high removal efficiencies are required. It is not widely used for grate boilers firing wood fuels due to the risk for fire. However, fabric filter is used after straw fired boilers, after fluidised bed boilers and after multicyclones.

Also the flue gas condensers remove some particles.

The particle concentrations were measured after the multicyclone, after the ESP and after the flue gas condenser after the 6 MW grate boiler fired with moist forest residues. So far only the number particle size distributions measured by SMPS for the submicrometer particles have been evaluated. The ESP particle removal efficiency curve is seen in figure 2.

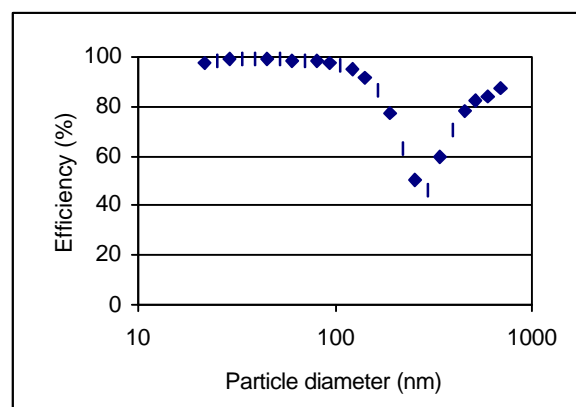

Figure 2. ESP particle removal efficiency versus particle diameter for a 6 MW boiler firing moist forest residues.

The minimum measured particle removal efficiency is found to be about 50%. This is a very low figure compared to results from coal fired power plants, where the maximum particle penetration was around 10% or about 90% minimum particle removal efficiency [5]. One reason is that this ESP only has one electrical field in the flue gas direction. An ESP as main dust collector after a coal fired plant has usually at least three or four fields in the flue gas flow direction.

5. HYGROSCOPIC PROPERTIES

The hygroscopic properties of submicrometer particles emitted after the multicyclone in a 1 MW boiler fired with forest residues were studied.

The hygroscopic properties of particles are very important for the behaviour in the atmosphere and could possibly also be important factor for the impact on the human health. The H-TDMA technique is used to study ambient air aerosols. In the ambient air several modes of

hygroscopicity are observed, less-hygroscopic, more-hygroscopic and sea salt. There is also a mode with more hydrofob particles, if fresh combustion aerosols are influencing the ambient aerosol [6].

The hygroscopic properties of carbon and diesel engine exhaust have previously been studied [7]. But there is not much information about the hygroscopic properties of combustion aerosols from stationary sources.

The fine particles after biomass combustion were studied with H-TDMA. The particles had a dry particle diameter in the range of 20-265 nm. These particles were then exposed to a relative humidity of 90%. The growth factor can be seen in figure 3.

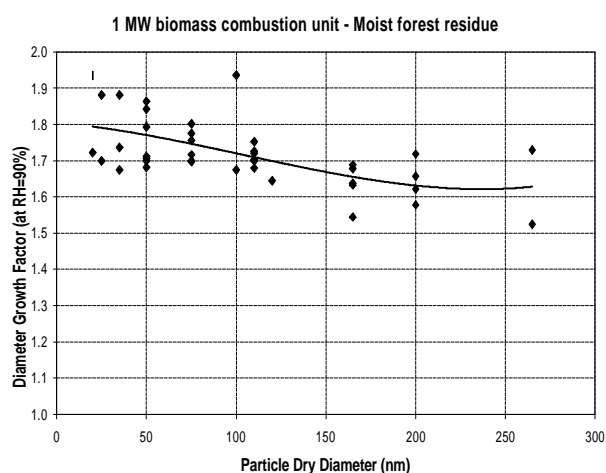

Figure 3. The particle growth factor vs. dry particle diameter for combustion of moist forest residues in the 1 MW combustion unit.

The measured growth factors are in the range of 1.5-1.95, which is relatively high and can be compared with the more hygroscopic fraction in ambient air.

The high growth rate can be explained by presence of alkali salts like KCl and K_2SO_4 . As previous mentioned potassium, chloride and sulphur are the main components in the submicrometer range according to the PIXE analysis. The unimodal shape of hygroscopic behaviour further indicates that the particles of a certain size have similar chemical composition.

6. CONCLUSIONS

The submicrometer particles formed during combustion of biofuels were studied. Potassium, chlorine and sulphur dominate the submicrometer particle chemical composition for the three different tested biofuels as measured by PIXE.

The ESP particle removal efficiency curve showed a minimum in the same particle size range as previously reported for ESPs after coal fired boilers.

The hygroscopic growth of particles with a dry diameter in the range of 20 to 265 nm was high and would be considered as more hygroscopic if classified in same way as an ambient aerosol. This is explained by the presence of high contents of alkali salts like KCl and K_2SO_4 . The unimodal behaviour also indicate that the particles of a certain size has a similar chemical composition

ACKNOWLEDGMENTS

This work is supported by the Swedish National Energy Administration (STEM) and Swedish Research Council for Engineering Sciences (TFR). Växjö Energi AB is acknowledged for their kind contribution during the test campaigns

REFERENCES

- [1] Swedish National Energy Administration: Energi-läget 2000 (In Swedish), November 2000
- [2] Valmari T, Kauppinen E, Jokiniemi J, Sfiris G and Revitzer H.: Fly ash formation and deposition during fluidized bed combustion of willow. *Journal of Aerosol Science*, 29 (1998), 445-459
- [3] Valmari T, Lind T and Kappinen E, Sfiris G, Nilsson K and Maenhaut W.: Field study and ash behaviour during circulating fluidized-bed combustion of biomass. 1. Ash formation. *Energy & Fuels*, 13 (1999), 379-389
- [4] Obernberger I.: Aschen aus Biomassefeuerungen – Zusammensetzung und Verwertung. *VDI Bericht 1319* (1997) 199-222
- [5] Helble J: A model for the air emissions of trace metallic elements from coal combustors equipped with electrostatic precipitators *Fuel Processing Technology*. 63 (2000), 125-147
- [6] Zhou J: Hygroscopic properties of atmospheric aerosol particles in various environments *PhD thesis, Department of Nuclear Physics, Lund University, Sweden, 2001*
- [7] Weingartner E, Burtscher H, Baltensperger U: Hygroscopic properties of carbon and diesel soot particles *Atmospheric Environment*. 31 (1997), 2311-2327

CHARACTERISATION AND FORMATION OF AEROSOLS AND FLY-ASHES FROM FIXED-BED BIOMASS COMBUSTION

I. Obernberger, T. Brunner, M. Jöller

Institute of Chemical Engineering Fundamentals and Plant Engineering, Graz University of Technology
Inffeldgasse 25, A – 8010 Graz, Austria
phone +43 (0)316 481300, fax +43 (0)316 4813004, email obernberger@glvt.tu-graz.ac.at

ABSTRACT: Aerosols and fly-ashes formed during biomass combustion cause considerable problems in regard to emissions and the availability and maintenance of combustion plants. Comprehensive research work on aerosol and ash formation as well as aerosol and ash related problems for various combustion systems and fuels has been carried out over the past few years. But there is still insufficient information available concerning fixed-bed combustion systems using woody biomass as fuel. This was the reason for launching the EU project ERK6-CT1999-0003, “Bio-Aerosols”, to which this paper is related. Within the context of this project test series were carried out with different woody biomass fuels (wood chips, bark, chipboards, waste wood) at a pilot-scale and at a large-scale combustion unit. The test runs included the characterisation of the fuel by its chemical composition, aerosol and fly-ash sampling as well as subsequent wet chemical and SEM-EDX analyses of the samples taken. Results from these test runs are presented in this paper. The results indicate that the concentration of coarse fly-ashes in the flue gas mainly depends on the ash content of the fuel and the operation mode of the combustion unit. The chemical composition and the concentration of aerosols in the flue gas are mainly influenced by the chemical composition of the fuel used. Three different types of aerosol formation processes were identified relating to three different types of woody biomass fuels, namely chemically untreated wood chips, bark and waste wood.

Keywords: fixed-bed biomass combustion, fly-ash formation, aerosol formation, aerosol characterisation

1. INTRODUCTION

Aerosols and fly-ashes formed during biomass combustion cause considerable problems in regard to emissions and the availability and maintenance of the combustion plants. Comprehensive research work concerning aerosol and ash formation as well as aerosol and ash related problems for various combustion systems and fuels has been carried out in recent years. But there is still insufficient information available concerning fixed-bed combustion systems using woody biomass as fuel. This was the reason for launching the EU project ERK6-CT1999-0003, “Bio-Aerosols” to which this paper is related.

The project focuses on the solution of problems related to aerosols and fly-ashes in fixed-bed biomass combustion systems, namely particulate emissions and deposit formation. Characteristics and the behaviour of aerosols were investigated considering different biomass fuels (bark, wood chips, waste wood). Test runs at a pilot plant and a large-scale CHP plant including aerosol, fly-ash and deposit sampling with subsequent chemical and electron microscopy analyses were performed to provide information about particle size distribution, shape and chemical composition of aerosols and fly-ashes. These data allow particulates to be characterised and the mechanisms of aerosol and ash formation and behaviour to be investigated with computer aided mathematical models. Additionally, mathematical flow simulations are used to describe the motion and deposit formation of aerosols and fly-ashes in furnaces and boilers. The knowledge gained from this basic research is to be used as a basis for the

follow-up investigations concerning aerosol precipitation and reduction of corrosive deposits. To optimise aerosol precipitation, an aerosol database as well as relevant design data for filter manufacturers will be worked out and subjected to a techno-economic evaluation. Moreover, additives injected into the furnace in order to influence formation, growth and chemical composition of aerosols will be developed and tested. Finally, the ecological and health risks of aerosol emissions from biomass combustion will be evaluated and compared to aerosol emissions from other sources as a basis for the recommendation of appropriate emission limits.

In this paper, results from comprehensive test runs, carried out during the first year of the project are presented. Important information concerning aerosol and fly-ash formation during fixed-bed biomass combustion of woody biomass can be derived from these data. These results form the basis for remaining work, especially the modelling work, to be performed within the project.

2. THEORY

Fly-ashes formed during biomass combustion, can be divided into two main fractions, aerosols and coarse fly-ashes [1].

2.1 Fly-ash formation

Coarse fly-ashes consist of ashes entrained from the fuel bed with the flue gas and therefore, consist mainly of refractory species. Their particle size can vary between some few μm up to about 200 μm .

2.2 Aerosol formation

During combustion volatile elements and compounds such as alkali metals, S, Cl and heavy metals are released from the fuel to the gaseous phase and subsequently undergo homogeneous gas phase reactions [2]. The vapour pressure of the resulting compounds is in most cases far higher than that of the reactants, so that these compounds form new particles by nucleation (size range: some nm) or condense on surfaces of existing particles. Formation of particles by nucleation and condensation of vapours on existing surfaces (either aerosols or coarse fly-ash particles) are always competing processes. The higher the surface area of existing particles is the more the formation of particles by nucleation is suppressed and the growth of existing particles by condensation is preferred. In the following agglomeration processes due to particle collision lead to the typical unimodal particle size distribution of the aerosol fraction in the size range below 1 μm .

To describe and understand these processes, comprehensive information about the elements and compounds involved as well as the basic mechanisms is needed. Data about characteristics of aerosols and fly-ashes such as shape, chemical composition, particle size distribution and concentration in the flue gas are therefore necessary. Regarding fixed-bed combustion of woody biomass fuels such kinds of information has so far only been available to a limited extent and therefore, the data and mechanisms presented in this paper should help to significantly increase the knowledge in this field.

3. EXPERIMENTAL

Test series were carried out at a pilot-scale combustion plant using different types of woody biomass fuels and at a large-scale CHP plant using waste wood. The technical data of the combustion plants are:

Pilot-scale plant

combustion technology: moving grate
 boiler technology: gas tube boiler
 nominal capacity: 440 kW_{th}
 fuels used: chemically untreated wood chips (beech, spruce), bark (spruce), fibreboards, waste wood.

Large-scale CHP plant:

combustion technology: moving grate
 nominal capacity: 40 MW_{th}
 boiler technology: water tube boilers (water cooled furnace, two super heater sections, economiser)
 fuel used: waste wood

During the test runs aerosol and fly-ash measurements as well as particle sampling were performed at boiler outlet at 180-220°C (pilot-scale plant) and 200°C (CHP-plant), respectively. To define the operation modes of the furnaces during the test runs, the most important operation data such as flue gas composition (CO, O₂, NO_x), furnace and flue gas temperatures, combustion air and flue gas flows as well as plant load were recorded by the process control systems and evaluated. In addition, fuel samples were taken and analysed by wet chemical methods.

The following aerosol and fly-ash measurements were performed and samples were taken.

- Aerosol sampling with a 9-stage Berner-type low-pressure impactor (BLPI) to determine the particle size distribution (PSD) and the concentration of aerosols in the flue gas as well as for subsequent wet chemical and SEM-EDX analyses of the samples taken.
- Particle sampling on a polycarbonate filter (pore size: 50 nm). The filters were mounted in a specially constructed filter holder, inserted into the flue gas channel and then, for a very short period (some seconds), flue gas was sucked through the filter. In this way a single layer of particles builds up on the filter and particle agglomerations can be avoided. The filters were used for single particle analyses by SEM-EDX.
- Total dust sampling with equipment according to VDI 2066. In this method flue gas is sucked through a filter holder containing quartz wool. The whole fly ash fraction is retained in the filter and thus, the fly-ash concentration can be determined from the mass of dust sampled divided by the flue gas flow sucked through the filter. Furthermore, the particles sampled were analysed by wet chemical methods.
- Sampling of coarse fly ash particles with a cyclone and subsequent analyses of the particle size distribution of the coarse fly ashes by a sedimentation technology (analyser: HELOS).

4. RESULTS

4.1 Characterisation of the fuel

In total 10 different fuels were used during the test runs. The fuels were beech (high and low moisture content), spruce (high and low moisture content), bark (spruce), fibreboards (coated and uncoated) as well as two different kinds of waste wood.

In Table 1 the different fuels used are characterised by their ash content, moisture content and chemical composition. Only elements which are supposed to be of relevance concerning aerosol and fly-ash formation are considered. Comparing the chemical compositions of these biomass fuels the following similarities and differences become obvious:

- Ca and Mg: the highest Ca contents by far can be found in bark. In most cases, the Mg content increases with increasing Ca content.
- Si: the higher silica concentrations in bark and waste wood are assumed to originate from mineral impurities (bark) and glass residues (waste wood).
- K: the K content of bark is significantly higher than that of wood chips (trunk wood).
- Na: the Na content of waste wood is significantly higher than that of the other fuels (possible reason: glass residues).
- Cl, S: concerning the chemically untreated biomass fuels, the highest S and Cl concentrations can be found in bark. At all events, the S and Cl concentrations in fibreboards can be even higher (depending on the production process and the glue used). The highest

concentrations of these elements by far can be found in waste wood.

- Heavy metals: the heavy metal content of bark is higher than that of trunk wood (wood chips). The highest heavy metal concentrations can be found in waste wood. The comparison of the Pb concentrations in fuel 3 and 10 in particular indicates the large possible varieties regarding the chemical composition of waste wood.

Table 1: Characterisation of the fuels used

Explanations: wc: wood chips; d.b.: dry base; w.b.: wet base

Fuel number		1	2	3	4	5
Fuel		spruce (wc)	bark	waste wood 1	beech (wc)	spruce (wc)
moisture content	wt.% w.b.	53.3	49.2	33.9	37.1	11.9
ash content	wt.% d.b.	0.33	5.61	4.96	0.93	0.29
Si	mg/kg d.b.	<400	2,251	9,039	781	349
K	mg/kg d.b.	513	2,878	1,192	1,201	238
Ca	mg/kg d.b.	789	12,122	9,863	2,772	947
Mg	mg/kg d.b.	124	820	1,417	327	85
Na	mg/kg d.b.	5	74	1,303	32	<10
Cl	mg/kg d.b.	97	159	1,184	53	23
S	mg/kg d.b.	<150	364	1,132	120	38
Zn	mg/kg d.b.	9.28	80.2	687	8.6	11.9
Pb	mg/kg d.b.	0.43	3.06	547	1.56	0.35
Cu	mg/kg d.b.	0.87	5.28	19.4	1.59	0.61
Cd	mg/kg d.b.	0.08	0.43	0.77	0.06	0.11

Fuel number		6	7	8	9	10
Fuel		fibre board 1	fibre board 2	beech (wc)	bark	waste wood 2
moisture content	wt.% w.b.	6.2	7.5	9.7	58.2	26.1
ash content	wt.% d.b.	0.96	1.00	0.58	6.62	4.38
Si	mg/kg d.b.	633	518	165	7,480	8,841
K	mg/kg d.b.	579	684	1,045	2,109	868
Ca	mg/kg d.b.	1,901	2,102	1,412	14,530	5,551
Mg	mg/kg d.b.	279	241	294	917	467
Na	mg/kg d.b.	182	301	<10	228	615
Cl	mg/kg d.b.	300	140	26	228	944
S	mg/kg d.b.	164	550	112	329	849
Zn	mg/kg d.b.	64.3	26.4	4.9	92.9	562
Pb	mg/kg d.b.	17.01	4.76	0.51	2.90	197
Cu	mg/kg d.b.	3.11	2.12	1.10	4.90	11
Cd	mg/kg d.b.	0.36	0.16	0.05	0.62	2

4.2 Concentration of fly-ashes in the flue gas

By definition, fly-ashes represent the total amount of ashes emitted from the furnace and consist of aerosols (particles <1µm) and coarse fly-ashes (particles >1µm). In Fig. 1 and Fig. 2 results from the fly-ash measurements at the pilot-scale combustion unit are summarised.

Fig. 1 clearly indicates that during the combustion of fuels with a high ash content such as bark and waste wood the fly-ash emissions are also high (Fig. 1). Only fibreboard 2 must be excluded from this statement, because in the case of this material the fly-ash emissions were in the range of those of bark and waste wood, while the ash content was significantly lower. This effect might be due to the very small particle size of the chipped fibreboards used. Fig. 2 shows an example of how the fly-ash concentration rises with the increasing load of the plant. The significance of this tendency increases with increasing levels of fly-ash

emissions (increasing ash content of the fuel). Since no significant effect of the load on the aerosol concentrations in the flue gas was noticeable in any of the test series (see section 4.3), this trend must be due to higher emissions of coarse fly-ash particles, which are in turn due to higher combustion air and flue gas flows and therefore, a resultant higher entrainment of ash and charcoal particles from the grate. The results from wet chemical analyses of the fly-ash samples taken indicate, that the fly-ash mainly contains Ca, Mg, K and Na. S, Cl and heavy metals were found in lower concentrations.

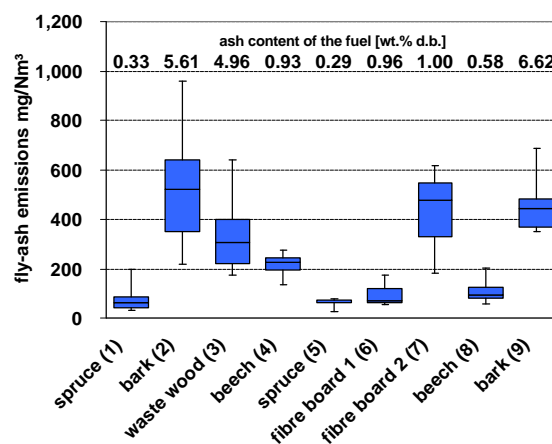

Figure 1: Ash content of the fuel and distribution of fly-ash emissions at boiler outlet

Explanations: all emissions related to dry flue gas and 13 vol.% O₂; fuel numbers according to Table 1

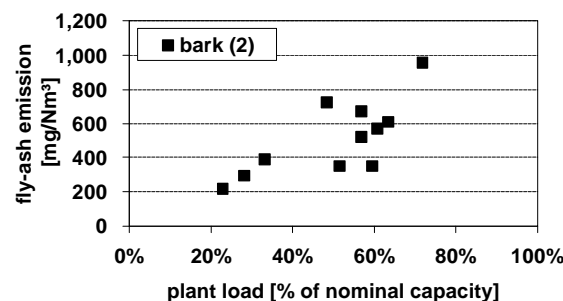

Figure 2: Fly-ash concentrations in the flue gas at boiler outlet

Explanations: nominal boiler capacity: 440 kW_{th}; fuel 2 according to Table 1; all concentrations related to dry flue gas and 13 vol.% O₂

The particle size distribution of the coarse fly-ashes turned out to be unimodal with a distinct peak in the range between 40 and 60 µm (aerodynamic diameter). The largest particles sampled with the cyclone were in the range of about 200 µm (aerodynamic diameter).

4.3 Particle size distribution of aerosols

The particle size distribution of the aerosols was determined with the BLPI and, in all cases, turned out to be an approximately logarithmic normal distribution (see Fig. 3). The concentration of aerosols in the flue gas increases from spruce (about 20 mg/Nm³ related to dry flue gas and 13 vol.% O₂) to bark (up to 60 mg/Nm³) and

waste wood (up to 160 mg/Nm³). The peak diameter of the PSD increases with increasing aerosol concentration, which indicates that the number concentration of aerosols formed is approximately constant (see Fig. 4). The most important parameter influencing the total mass of aerosols formed during combustion is the amount of volatile aerosol forming elements from the fuel, which mainly depends on the chemical composition of the fuel. The scattering of the total aerosol emission is assumed to be due to the inhomogeneity of the fuels. Basically, these results are comparable with results obtained from straw combustion [3].

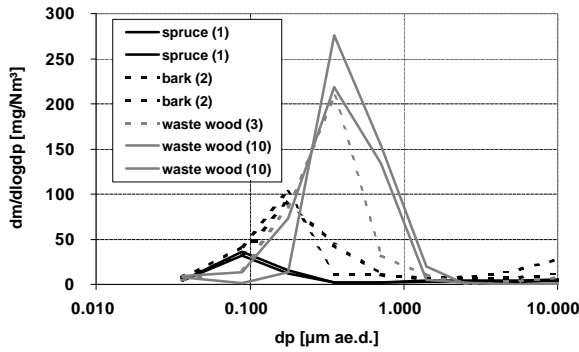

Figure 3: PSD of aerosols formed during the combustion of different biomass fuels in grate fired boilers

Explanations: emissions related to dry flue gas and 13 vol.% O₂; ae.d.: aerodynamic diameter; numbers in () indicate the fuel numbers (see Table 1)

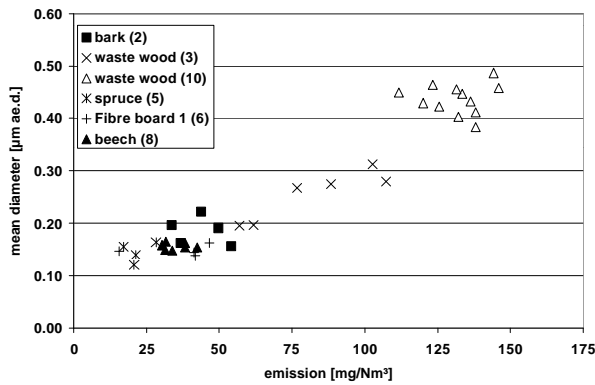

Figure 4: Mean diameter of the aerosol fraction vs. aerosol emissions

Explanations: emissions related to dry flue gas and 13 vol.% O₂; ae.d.: aerodynamic diameter; numbers in () indicate the fuel numbers (Table 1)

4.4 Chemical composition of aerosols

Two different methods were chosen to determine the chemical composition of the aerosol fraction. Wet chemical analyses of the aerosol samples taken with the BLPI and SEM-EDX analyses of particles sampled with polycarbonate filter membranes were performed. In Fig. 5 and 6 the results of these analyses for wood chips (beech and spruce), bark and waste wood are presented.

wood chips (beech) (8)

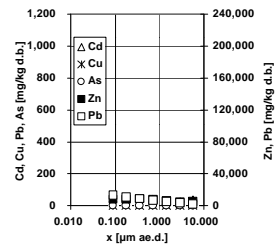
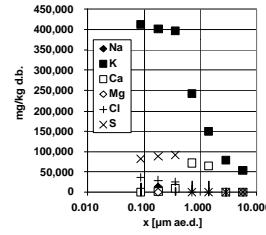

bark (2)

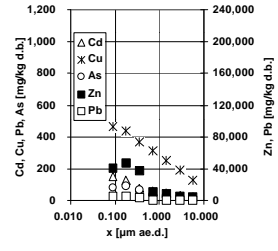
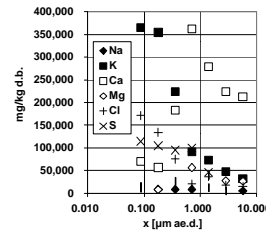

waste wood (3)

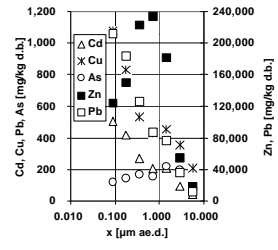
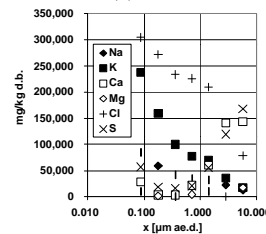

Figure 5: Chemical composition of aerosols

Explanations: ae.d.: aerodynamic diameter; d.b.: dry base, numbers in (): fuel numbers according to Table 1

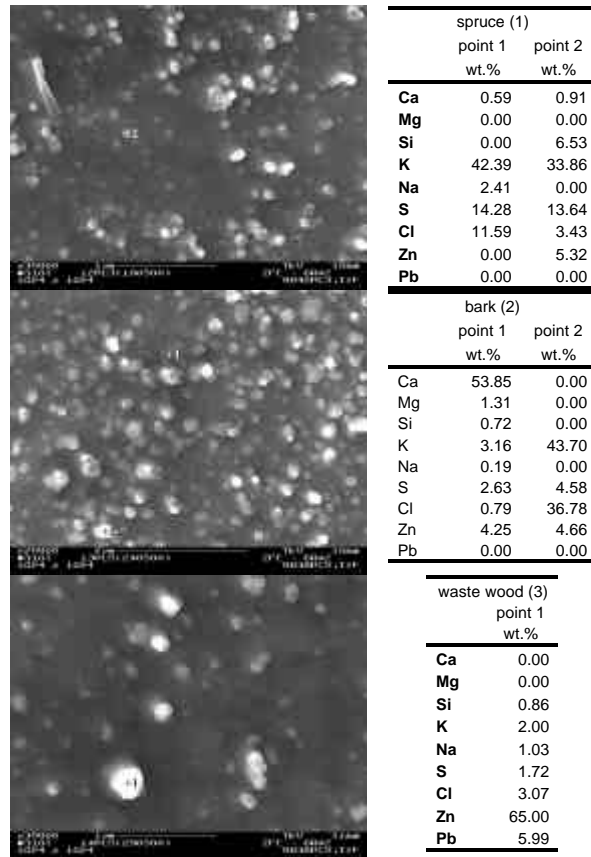

Figure 6: SEM images and EDX spectra of aerosols

Explanations: numbers in (): fuel numbers according to Table 1

The results presented in Fig. 5 to Fig 6 are typical of the type of biomass fuel concerned under fixed-bed combustion conditions and allow a distinction to be made between three different cases with regard to formation and chemical composition of aerosols. These cases are represented by three types of fuels, which are chemically untreated wood chips, bark and waste wood and should be understood as basic schemes which also allow certain overlapping due to the possible variations in the chemical composition of these fuels. The different aerosol formation processes suggested are indicated in Fig. 7 to Fig. 9.

Case 1: Chemically untreated wood chips:

Aerosols mainly consist of K, S and Cl. The concentration of K increases with decreasing particle diameter. With rising particle diameter (in the range $> 0.8\mu\text{m}$) the Ca content increases. From these data it can be derived that K sulphates and chlorides formed by homogeneous gas phase reactions, cause homogeneous nucleation of aerosol particles and/or condensation on existing surfaces.

Since Ca is only relevant for the size range $>0.8\mu\text{m}$, Ca-rich particles are part of the coarse fly-ash fraction and therefore, only influence the aerosol formation by offering surface areas for the condensation of metal vapours.

The heavy metal content of the particles is comparably low, which is due to the low heavy metal content of the fuel (see also Table 1). Since the concentrations of Pb, Zn, As and Cd increase with decreasing particle diameter, condensation on the surface of the existing aerosol particles or surface reactions are most probably the routes of heavy metals from the gaseous to the solid phase, which in turn means that the heavy metals condense after primary particles have already been formed. In regard to fibre-boards it must be mentioned that the heavy metal content of the fuel can vary due to the production process used and it could therefore also be possible that higher heavy metal contents of the fuel cause an aerosol formation behaviour which is comparable with that described in case 3.

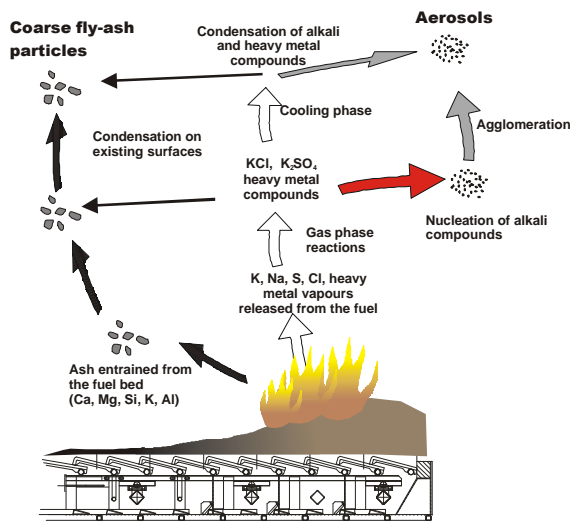

Figure 7: Aerosol formation during fixed-bed combustion of chemically untreated wood chips

Case 2: Bark

Aerosols formed during the combustion of bark mainly consist of K, Cl and S but also of considerable amounts of Ca and heavy metals such as Zn and Pb. In respect to Ca, it must be mentioned that, according to the thermodynamic data of Ca, a release of Ca to the vapour phase is not possible. Consequently, it must be assumed that very small Ca particles already exist in the flue gas directly after the flue gas leaves the fuel bed. Subsequently, one part of the KCl and K_2SO_4 , which are the next compounds that should condense, will form new particles by nucleation but will also condense on the surface of the existing Ca nuclei. The quantity of newly formed particles and the amount of condensed alkali chlorides and sulphates on surfaces depend on the surface area that the Ca particles and the entrained coarse fly-ash particles can provide. The formation of the Ca particles in the submicron range, cannot be explained at present, and further investigations concerning this point will therefore be performed within the project.

The increasing Ca and Mg content of particles $>1\mu\text{m}$ is due to mineral and ash particles entrained from the fuel bed with the flue gas and thus forming a part of the coarse fly-ash fraction.

Concerning the condensation of heavy metals on the surfaces of existing particles, the same as stated regarding wood chips is valid, even if the Zn-, Pb-, Cu and Cd-concentrations are higher than in aerosols formed during wood chips combustion.

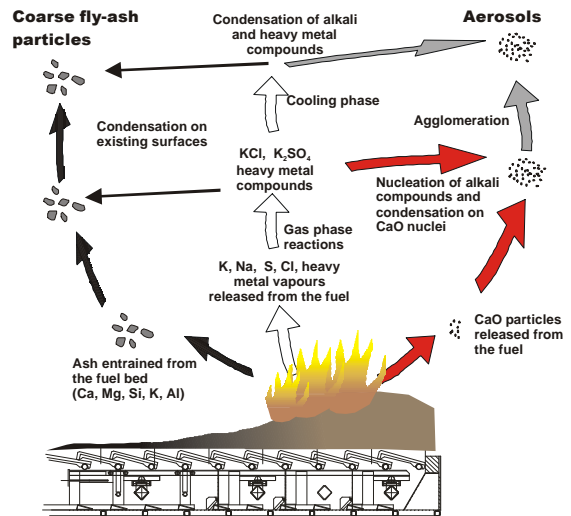

Figure 8: Aerosol formation during fixed-bed combustion of bark

Case 3: Waste wood

The most obvious differences between chemically untreated biomass fuels and waste wood are the heavy metal concentrations (specially Zn and Pb), which are by far higher in waste wood. It is well known that in a reducing atmosphere elemental Zn can evaporate at high temperatures [4]. In this way Zn is released from the fuel bed to the gaseous phase and subsequently reacts with oxygen. The vapour pressure of the resulting ZnO is very high and an immediate supersaturation followed by nucleation of ZnO is thus assumed to occur. These ZnO

particles subsequently agglomerate and therefore, the Zn concentration does not (as in the case of bark and wood chips) increase with decreasing particle diameter but follows the particle size distribution. Due to the high surface area of the ZnO particles formed, nucleation is suppressed and volatile species (e.g.: alkali chlorides, lead compounds) condense with decreasing temperature of the flue gas on these surfaces.

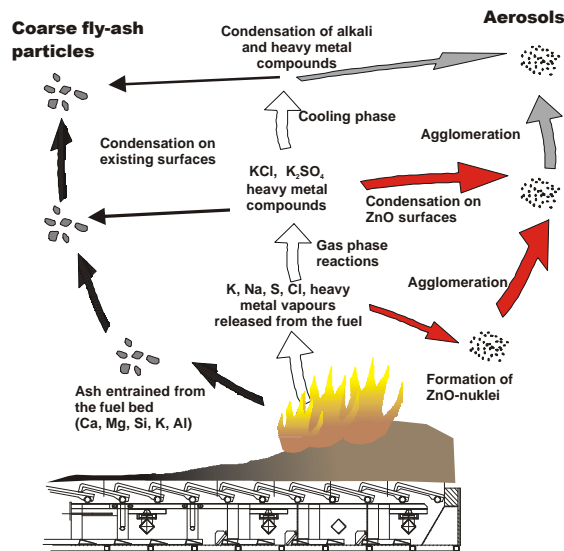

Figure 9: Aerosol formation during fixed-bed combustion of waste wood

5. CONCLUSIONS

The following conclusions concerning fly-ash and aerosol formation during fixed-bed biomass combustion of woody biomass can be derived from the data presented in this paper:

In general, the particle size distribution of fly-ashes is always bimodal with one peak in the submicron range (aerosols) and one peak in the range larger 1 μm (coarse fly-ash particles).

Concerning fly-ash formation it was observed that when a specific fuel is burned under different operational conditions, the coarse fly-ash particles mainly influence the concentration of fly-ashes in the flue gas while the amount of aerosols formed during the combustion of a certain fuel is fairly constant. The following parameters were shown to influence coarse fly-ash formation during the test runs:

- The ash content of the fuel - fly-ash emissions increase with increasing ash content of the fuel.
- The load of the combustion unit - fly-ash emissions increase with increasing load of the combustion unit.
- The operation mode - it was observed that the distribution of combustion air or recirculated flue gas can also have a secondary influence on the amount of fly-ashes entrained from the fuel bed.

Additionally it is well known that the combustion technology (fixed-bed versus fluidised bed) also influences the fly-ash emissions from the furnace, but, since the project focuses on fixed-bed combustion

technologies, the investigation of this effect is not part of the project's work plan.

Concerning aerosol formation, the following conclusions can be drawn:

- The concentration of aerosols is mainly influenced by the chemical composition of the biomass fuel.
- The peak diameter of the particle size distribution of aerosols depends on the total mass of aerosols formed. Consequently, the total number of aerosols formed remains quite constant.
- No direct influence of flue gas recirculation on the particle size distribution was detected.
- Concerning the aerosol formation mechanisms during combustion of woody biomass fuels, 3 main types of fuels must be distinguished, which are chemically untreated wood chips (aerosol formation dominated by alkali metal salts), bark (differences to wood chips regarding Ca behaviour) and waste wood (significant influence of heavy metals, primarily Zn and secondarily Pb on aerosol formation and growth). These mechanisms have to be proven by mathematical modelling and thermodynamic and kinetic investigations, which will be one of the next steps within the project.

To predict the concentration and composition of aerosols and coarse fly-ashes in the flue gas, detailed information is required about the release of the aerosol forming compounds from the fuel and the entrainment of coarse fly-ash particles from the fuel bed at different operational conditions of a combustion unit. There is a considerable need for additional research work with regard to these subjects in particular.

ACKNOWLEDGMENTS

This research is supported by the European Commission under Contract ERK6-CT-1999-0003, "Bio-Aerosols".

REFERENCES

- [1] OBERNBERGER I., DAHL J., BRUNNER T., 1999: Formation, Composition and Particle Size Distribution of Fly Ashes from Biomass Combustion Plants. In: Proceedings of the 4th Biomass Conference of the Americas, Sept 1999, Oakland (California), USA, ISBN 0 08 043019 8, Elsevier Science Ltd. (Ed.), Oxford, UK, pp. 1377-1385
- [2] FRIEDLANDER S.K., 1977: Smoke Dust and Haze, John Wiley and Sons, New York, USA
- [3] CHRISTENSEN K. A., 1995: The Formation of Submicron Particles from the Combustion of Straw, Ph.D. Thesis, ISBN 87-90142-04-7, Department of Chemical Engineering (ed), Technical University of Denmark, Lyngby, Denmark
- [4] OBERNBERGER I., 1998: Fractionated heavy metal separation in Austrian biomass-fired grate combustion plants – approach, experiences, results, in: Ashes and particulate emissions from biomass combustion, Series Thermal Biomass Utilization, Vol. 3, BIOS (ed.), Graz, Austria, dbv-Verlag, ISBN 3-7041-0254-7

**BEHAVIOUR OF ASH FORMING COMPOUNDS IN BIOMASS FURNACES -
MEASUREMENT AND ANALYSES OF AEROSOLS FORMED DURING FIXED-BED
BIOMASS COMBUSTION**

T. Brunner¹, I. Obernberger¹, M. Jöller¹, A. Arich¹, P. Pölt²

¹Institute of Chemical Engineering Fundamentals and Plant Engineering, Graz University of Technology
Inffeldgasse 25, A – 8010 Graz, Austria

phone +43 (0)316 48130013, fax +43 (0)316 4813004, email brunner@bios-bioenergy.at

²Research Institute for Electron Microscopy, Graz University of Technology
Steyrergasse 17/III, A-8010 Graz, AUSTRIA

ABSTRACT: The project focuses on the investigation of several ash-related problems in fixed-bed combustion of woody biomass; namely aerosol formation, deposit formation influencing aerosol formation and the behaviour of heavy metals. Within all of these research fields the characterisation of aerosols and fly-ashes is a major step of the methodology. In this paper two methods, wet chemical analyses as well as scanning electron microscopy (SEM) and energy dispersive X-ray spectrometry (EDX) are presented as suitable tools for the characterisation of particulates concerning their shape, structure and chemical composition. Therefore, different sampling methods, such as particle sampling with a 9-stage Berner type low-pressure impactor (BLPI), total dust sampling and particle sampling with polycarbonate filters were applied during test runs at fixed-bed furnaces. The samples were forwarded for wet chemical and SEM-EDX analyses. In this paper the results of the analyses as well as the advantages and disadvantages of the different sampling and analytical methods are discussed on the basis of the results from these test runs. Furthermore, a sampling and analysing strategy for future test runs performed within the project is developed consisting of different types of particle sampling coupled with proper analytical methods to achieve a maximum of information about the main characteristics of aerosols and fly-ashes formed during biomass combustion.

Keywords: fixed-bed biomass combustion, particulates, SEM-EDX, wet chemical analyses

1. INTRODUCTION

The project “Behaviour of ash-forming compounds in biomass furnaces” (financed by the Austrian Science Fund), to which the paper is related, focuses on the investigation of several ash- and aerosol-related problems in fixed-bed biomass combustion, namely aerosol and fly-ash formation, deposit formation as well as the behaviour of heavy metals during biomass combustion. Furthermore, primary and secondary measures designed to influence the formation and growth of aerosols will be investigated. The project includes theoretical modelling approaches as well as test runs with ash, fly-ash, aerosol and deposit sampling at pilot-scale (nominal boiler capacity: 440 kW_{th}) and medium-scale combustion units (nominal boiler capacities up to 4,000 kW_{th}) and subsequent chemical analyses of the samples taken. Concerning the biofuels considered, the main interest is put on woody biofuels such as wood chips, bark and waste wood, which are commonly used in Austrian applications.

The results derived from the test runs are on the one hand important for the characterisation of particulates formed during combustion and on the other hand they will be used to set-up, calibrate and validate the models. Appropriate sampling and analysis methods for particulates thus had to be chosen in order to obtain high quality data for the

theoretical part of the work. The main characteristics of interest are:

- concentrations of aerosols and coarse fly-ashes in the flue gas,
- particle size distribution (PSD) of aerosols and coarse fly-ashes,
- shape of aerosols and coarse fly-ashes,
- chemical composition of aerosols and coarse fly-ashes

This paper presents the different methods used for the characterisation of particulates (aerosols and fly-ashes) formed during biomass combustion with special respect to the chemical analyses of the samples.

2. THEORY

Solid emissions from biomass furnaces can be divided into 3 main fractions, which are the bottom ash, furnace ash and fly-ashes. By definition, fly-ashes are all particles emitted from a furnace and can be divided into two fractions, the coarse fly-ashes (particles >1 µm) and aerosols (particles <1 µm) [1]. Concerning ash-related problems such as deposit formation and particulate emissions fly-ashes are of major interest.

Coarse fly-ashes consist of ashes entrained from the fuel bed with the flue gas and therefore, mainly consist of refractory species. Their particle size can vary between some few µm up to about 200 µm.

During combustion volatile elements and compounds such as alkali metals, S, Cl and heavy metals are released from the fuel to the gaseous phase and subsequently undergo homogeneous gas phase reactions. The vapour pressure of the resulting compounds is in most cases far higher than that of the reactants, so that particles are formed by homogenous nucleation and condensation.

To understand these mechanisms comprehensive information about the governing characteristics of aerosols and coarse fly-ashes such as particle size distribution, shape, structure, chemical composition and concentration in the flue gas must be obtained from test runs. This paper presents sampling methods as well as analytical methods for aerosols and fly-ashes, from which the mentioned relevant data can be derived. According to the basically known formation mechanisms of aerosols and fly-ashes the elements Ca, Si, Mg, Na, K, S, Cl, Zn and Pb are of importance for the chemical analyses of particle samples. The analytical methods described thus mainly focus on these elements.

3. EXPERIMENTAL

Test runs at pilot-scale and medium-scale combustion units using different types of woody biomass fuels such as chemically untreated wood chips, bark and waste wood were performed. All furnaces at which these samplings took place were fixed-bed furnaces equipped with either a moving grate or an underfeed stoker.

3.1 Particle sampling

To achieve a maximum of information about the characteristics of aerosols and fly-ashes as mentioned, several sampling methods were used to provide proper samples for the respective analytical methods mentioned in sections 3.2 and 3.3. All samples were taken at the boiler outlet at 180 – 220°C.

- Aerosol sampling with a 9-stage Berner-type low-pressure impactor (BLPI) was performed to determine the particle size distribution (PSD) and the concentration of aerosols in the flue gas as well as for subsequent wet chemical and SEM-EDX analyses of the samples taken.
- Particle sampling on polycarbonate filters (pore size: 50 nm) was carried out. The filters were mounted in a specially designed filter holder, inserted into the flue gas channel and then, for a very short period (some seconds), flue gas was sucked through the filter. In this way a single layer of particles builds up on the filter and particle agglomerations can be avoided. The filters were analysed by SEM-EDX.
- Total dust sampling with equipment according to VDI 2066. In this method flue gas is sucked through a filter holder containing a quartz wool filter, which is inserted into the flue gas. The whole fly-ash fraction is retained in the filter and thus, the fly-ash concentration can be determined from the mass of dust sampled divided by the flue gas flow sucked through the filter. Furthermore, the particles sampled can be analysed by wet chemical methods.

3.2 Wet chemical analyses

Wet chemical analyses can be applied to determine the chemical composition of particle collectives. While wet chemical analyses of quartz filters from the total dust measurement can only give information about the chemical composition of the whole fly-ash fraction emitted from the furnace, the investigation of BLPI separation foils can provide more specific data. With respect to the cut diameters of the single BLPI stages, the distribution of certain elements considering different size fractions can be evaluated from these measurements.

The following digestion and detection methods, which have already proven their applicability in former biomass ash related projects [2, 3, 4] were applied:

- With regard to Ca, Si, Mg, Na, K, S, Zn and Pb: multi-step pressurised digestion with HNO₃/HF/H₃PO₄; detection according to detection limits with atomic adsorption spectrometry (AAS) or plasma emission spectrometry (ICP-MS).
- With regard to Cl: Elution (24 h) with bi-distilled water and detection according to detection limits by ion chromatography (IC) or capillary electrophoresis (CE).

Some relevant restrictions must be mentioned concerning the accuracy of the results obtained from wet chemical analyses:

- The sample intake of aerosol particles from BLPI stages is in the range of 50 to 2,000 µg. Therefore, a micro balance with a high resolution must be used for weighing the samples. Furthermore, especially when analysing samples with low particle mass, the impact of the weighing error must be considered during the evaluation of the results.
- The aluminium foils used as collection substrates in the BLPI result in marginal contamination of the analytes, which generate a specific background. Moreover, the contamination may be slightly different from foil to foil.
- The assembling and reassembling of the BLPI as well as the sampling itself takes place in an environment which is definitely different to that of a clean room.
- The background level caused by ubiquitous elements depends on the quality of the chemicals used, the carefulness of the sample preparation and the air quality of the laboratory where the analyses are carried out.

In general, by using ICP-MS, the determination limits of the analyser for the mentioned elements of interest are not the limiting factor for the quality of the data generated. The accuracy of the results mainly depends on the carefulness with which the samples are collected, prepared and measured. Therefore, basic requirements during particle sampling such as accurate weighing, careful assembling and de-assembling of the device used for sample taking and the storage of the samples in possibly clean and dry atmosphere must be met.

3.3 Electron microscopy

Scanning electron microscopy (SEM) and energy dispersive X-ray spectrometry (EDX) have turned out to be powerful tools for analysing fly-ash and aerosol samples [5]. They allow the shape and structure of distinct single particles as well as their chemical composition to be detected. Applying state-of-the-art hardware and

software the methodology works in a size range down to 20 nm with high accuracy.

Samples from the BLPI as well as the polycarbonate membranes were analysed by SEM-EDX. As previously mentioned, the BLPI samples always consist of a high number of agglomerated particles. It is thus only possible to check the results from the wet chemical analyses by SEM-EDX but not to obtain detailed information about single particles. For that purpose the samples taken with the polycarbonate membranes are analysed.

To avoid interactions of the particles with condensing water vapour, the samples must be stored in a dry atmosphere during transport. Then a small part of the filter or impactor foil is cut off and prepared for the analyses. To avoid specimen charging, the specimens are coated with a thin carbon layer (approximately 20-30nm). The following equipment was used for the analyses:

- Philips SEM 505 + EDAX DX4 (Si(Li) detector, ultrathin window) + Robinson BSE – detector + Microspec WDX – 2A;
- Leo Gemini DSM 982 (field emission) + Oxford cooling stage (nitrogen) + Noran Voyager (Si(Li) detector, ultrathin window).

Some restrictions must also be mentioned concerning the application of SEM and SEM-EDX.

- Since the surface of the polycarbonate membrane is not a perfect plane, the electron beam is scattered and signals from the membrane surface next to the particle are detected together with signals emitted from the particle itself. This effect decreases with increasing particle diameter.
- When analysing particles in the range of some 10 nanometers in particular, the penetration depth of the electron beam is greater than the particle size. Therefore, the C and O signals consist of contributions of both, the membrane and the particle. This effect decreases with increasing particle diameter and decreasing penetration depth of the electron beam (lower primary electron energy).

This influence of the membrane must be considered when evaluating the results for oxygen especially when investigating particles in the submicron range.. Since the coating mentioned is also made from carbon, the C signals cannot be used for evaluation

It must further be taken into consideration that SEM-EDX analyses of polycarbonate filters allow only a small section of the filter to be examined. Due to the geometry of the filter holder separation effects, which can affect the distribution of coarse particles (not that of aerosols) can occur because of different flow conditions across the filter area.

SEM-EDX offers a wide range of different possibilities to analyse single particles and particle collectives.

- With area and line scans it is possible to determine not only the composition of a certain point but also the distribution of elements over the surface area of a particle.
- The energy of the electron beam can be varied in particular when analysing large coarse fly-ash particles. In this way the penetration depth of the electron beam is also varied and it is therefore possible to analyse different layers of the particle.

- X-ray mapping allows for an automated qualitative analysis of a great number of single particles concerning the distribution of the elements. Due to the overlapping of some X-ray peaks (e.g.: S and Pb) and the low counting rate per pixel, the information obtained from these analyses is qualitative rather than quantitative and therefore, only provides an overview of a larger area of the sample.
- By performing CCSEM analyses (automated analyses of a high number of particles) it is possible to detect all particles within a detection area and determine their chemical composition as well as their size and shape. With regard to CCSEM analyses of aerosols it must be mentioned that certain problems with specimen drift occur, but the resulting error can be reduced significantly by using proper software tools [6].

4. RESULTS

4.1 Chemical composition of fly-ashes in the flue gas

The results form the total fly-ash measurements (aerosols and coarse fly ashes) clearly indicate, that the concentration of fly-ashes mainly depends on the ash content of the fuel and the load of the combustion unit. The emissions can amount from about 100 mg/Nm³ (related to dry flue gas and 13 vol.% O₂) when burning fuels with a low ash content such as chemically untreated wood chips at low load up to about 1,000 mg/Nm³ or when burning fuels with a high ash-content such as bark at high load. The chemical analyses of the fly-ash show that Ca, Mg, Na and K are the most important elements. In Table 1 typical compositions of fly-ashes from wood chips and bark combustion are shown.

Table I: Compositions of fly-ashes formed during wood chips and bark combustion

Explanations: d.b. ... dry base; n.d. ... not detectable

		Wood chips	Bark
Na	mg/kg d.b.	101,176	9,368
K	mg/kg d.b.	222,776	172,474
Ca	mg/kg d.b.	111,216	262,139
Mg	mg/kg d.b.	23,522	30,610
Cl	mg/kg d.b.	8,464	77,189
S	mg/kg d.b.	22,623	47,744
Zn	mg/kg d.b.	3,049	12,726
Cd	mg/kg d.b.	14.2	28.8
Cu	mg/kg d.b.	n.d.	330
Pb	mg/kg d.b.	232	609

As mentioned in section 3.2, wet chemical analyses of filters from total dust measurements can only provide data about the composition of a fly-ash collective sampled during a specific period. To obtain reliable results, a minimum of about 10 mg fly-ash has to be sampled on the filter and consequently, when performing measurements downstream a highly efficient dust separator (such as a baghouse filter), the sampling time needed can be up to two hours due to the extremely low fly-ash concentrations.

4.2 Bulk composition of aerosols

Fig. 1 shows results from wet chemical analyses and SEM-EDX analyses performed on samples taken with the BLPI. A small section of the separation foils was thus cut off and forwarded for SEM-EDX analyses while the major part of the foils was analysed by wet chemical methods.

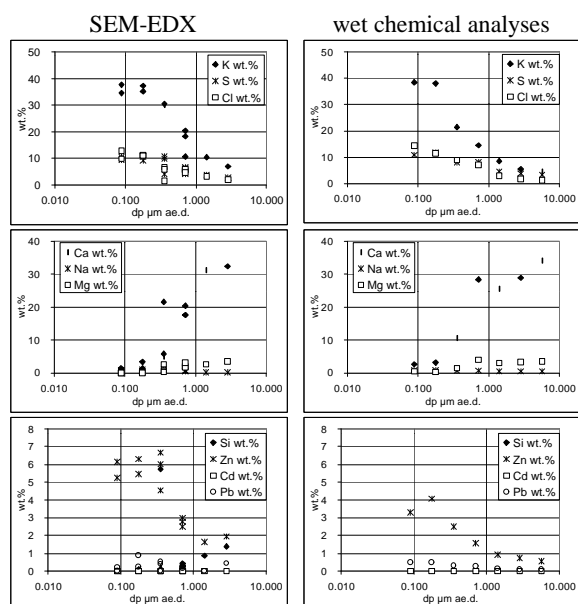

Figure 1: Comparison of results from SEM-EDX and wet chemical analyses of BLPI foils.

Explanations: fuel: bark, ae.d.: aerodynamic diameter

A comparison of the results in Fig. 1 clearly shows that the level of correspondence concerning the two technologies can be divided into three groups:

- Elements with high concentrations: the results for K, S, Cl and Ca, which are the main compounds detected with both methods fit well. Both, the absolute values of the concentrations and the tendencies with respect to the particle size show nearly equal results.
- Elements with low concentrations: for elements, which are found in low concentrations, such as heavy metals, more or less high deviations are noticeable. This is due to effects caused by electron scattering, which make the detection with SEM-EDX at such low concentration levels less accurate. On the other hand, in the case of Si detection, the detection limit of the wet chemical methods is far higher than for other elements (which is mainly due to the digestion method used), and therefore this element can only be detected by SEM-EDX at low concentrations.
- Elements which are not evenly distributed across the sampling area: during the SEM analyses it was observed, that Zn especially was not found at the same concentration level at different locations on the sample surface. Since the area analysed by SEM-EDX is limited (only some μm^2), representative results for an element distribution of this kind cannot be guaranteed.

It must always be taken into consideration when comparing results from wet chemical analyses and electron microscopy, that due to the limited surface which

can be detected during a single scan, deviations caused by the inhomogeneous distribution of the compounds will always occur.

4.3 Shape and composition of single particles

The bulk compositions of fly-ashes and of different aerosol size fractions can be determined using the methods described in section 4.1 and section 4.2, respectively. Since, however, information about single particles is still not obtained, analyses of the polycarbonate filters which can provide this kind of information were performed.

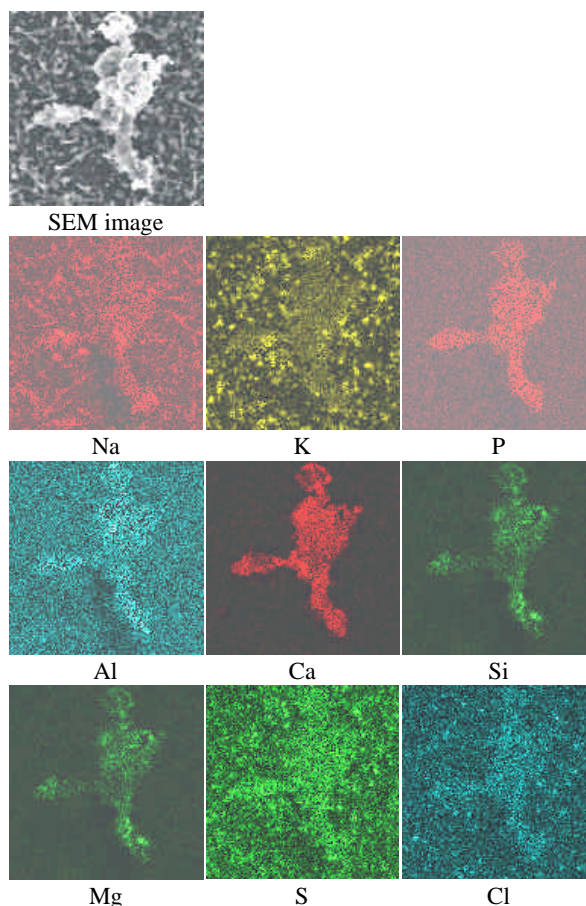

Figure 2: SEM image and X-ray mappings of coarse fly-ash particle and aerosols

Explanations: fuel: wood chips, spruce; picture width: 8.82 μm , electron energy: 7 keV

In Fig. 2 a SEM image from a coarse fly-ash particle and aerosols taken from a polycarbonate filter are shown. To give a rough overview of the element distribution in this frame X-ray mapping was performed. The X-ray mapping clearly indicates the difference concerning shape and composition of coarse fly-ash particles and aerosols. From Fig. 2 it can be derived that the aerosol fraction mainly consists of Na, K, S and Cl, while the main components of the coarse fly-ash particle are Ca, Si, Mg and Al. Also smaller amounts of K and Na are detected in the coarse particle. These results fit well with the result from the analyses of the BLPI samples (Fig. 1) and the quartz filters from the total dust measurements (Table 1).

In Fig. 3 a SEM image and EDX analyses of particles sampled during the same test runs with wood chips are shown. Concerning the shape of the aerosol particles obviously two different types, namely approximately spherically shaped particles and bars are detected. SEM-EDX analyses have revealed that these types of particles differ significantly in their chemical composition:

- The bars consist of high amounts of Na and K as well as smaller amounts of Zn and Ca. Due to the low S and Cl concentrations detected, these particles are supposed to be mainly carbonates [7].
- Far higher K and S concentrations were detected with regard to the approximately spherical particles. The concentrations of Na are significantly lower and Ca is altogether absent. K is assumed to form sulphates in such cases due to the high S concentrations.

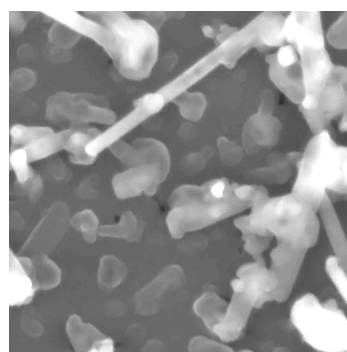

	bars	spheres
	wt. %	wt. %
Na	49.2	16.3
S	1.4	15.6
Cl	2.0	4.9
K	34.9	59.4
Ca	7.9	0.0
Zn	4.5	3.4
Pb	0.0	0.5

Figure 3: SEM image and SEM-EDX analyses from aerosols

Explanations: fuel: wood chips and saw dust (spruce) picture width: 2.29 μm , primary electron energy: 7 keV; C and O not analysed and considered

Another example, illustrating the use of evaluating the results from wet chemical analyses with respect to the results of analyses by electron microscopy is shown in the following. The data are taken from test runs carried out at a pilot-scale plant firing waste wood. In Fig. 4 the particle size distribution of the aerosol mode determined from the BLPI measurement and results from wet chemical analyses of the BLPI separation foils are shown.

Comparing the chemical composition of aerosols formed during waste wood combustion with those formed during the combustion of chemically untreated wood, the main difference can be seen in the concentrations of heavy metals and of Cl. In Fig. 5 a SEM-image and an X-ray mapping of a sample taken during the same test run at the same sampling board with a polycarbonate membrane is shown.

Again, differently shaped particles can be seen in the SEM image. In this case, bar-shaped particles mainly consist of Pb, Cl, K and S (presumably Pb_2KCl_5 , or a mixture of PbCl_2 , KCl , K_2SO_4 and PbSO_4), while spherically shaped particles contain high concentrations of Zn (presumably ZnO).

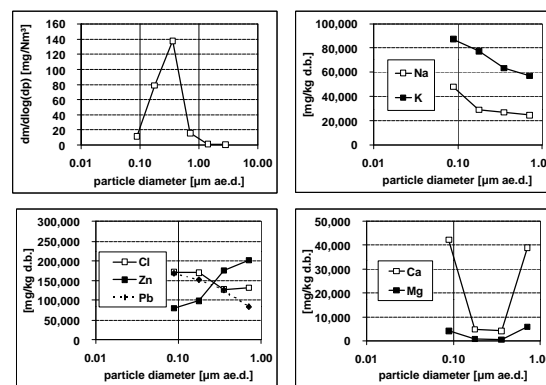

Figure 4: Particle size distribution and results from wet chemical analyses from waste wood combustion

Explanations: ae.d.: aerodynamic diameter; concentration related to dry flue gas and 13 vol.% O_2 , d.b.: dry base

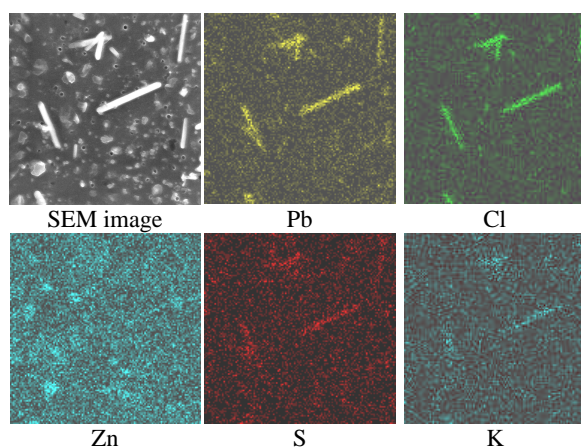

Figure 5: SEM image and X-ray mapping of aerosols formed during waste wood combustion

Explanations: picture width: 3.8 μm , primary electron energy: 7 keV

From the different methods shown above comprehensive information about certain characteristics of single particles can be derived, but statistically, the results are uncertain. Therefore, CCSEM analyses of polycarbonate filters were of interest. In this analyses the geometric properties (surface, area, diameter) and the chemical composition of a high number (some 1000) of particles is automatically detected. This method is very time consuming, and due to the small diameters of aerosols, special software is needed to correct specimen drifts. First test with CCSEM analyses of samples taken with polycarbonate filters have already been performed. In Fig. 6 the results concerning the particle size distribution are compared with the results from BLPI measurements concerning their plausibility. As Fig. 6 shows, also reliable results concerning the PSD of aerosols can be gained from CCSEM-analyses. Concerning the chemical composition of the particles cluster analyses will be performed with the data gained to determine the compounds which mainly form the single aerosol particles. The work concerning this has just begun

thus no results can be presented at the moment. Since, for the determination of the PSD, proven and less time consuming methods already exists, the big advantage of CCSEM analyses will be the information gained from the cluster analyses.

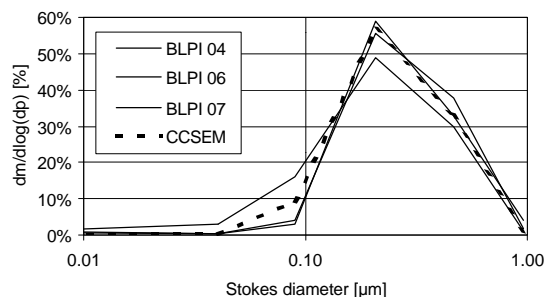

Figure 6: CCSEM-analyses of aerosols sampled with a polycarbonate filter compared with results from BLPI measurements

Explanations: fuel: waste wood; data from the CCSEM analyses grouped in size fractions according to cut diameters of the BLPI-stages; in total 4,381 particles detected

5. CONCLUSIONS

The results presented clearly indicate that both methods, wet chemical analyses and analyses by SEM and SEM-EDX, provide comparable results concerning the chemical composition of aerosols and fly-ashes. Valuable information can be achieved from these techniques for research into aerosol and fly-ash formation and behaviour in biomass combustion units.

The evaluation of the results from the measurements with the total dust measurement equipment and the BLPI provides the basic information about the particle load and the particle size distribution of aerosols and fly-ashes.

By means of wet chemical analyses it is possible to obtain highly accurate results about the concentrations of the elements in particle collectives. The depth of information gained from this method depends on the sampling technology used. While wet chemical analyses of total dust samples can give an overview over the composition of the whole particle collective emitted from a combustion unit, information about the distribution of the elements related to different size fractions can be achieved from analysing BLPI foils.

Information concerning the shape, structure and chemical composition of single aerosols and fly-ash particles is still needed, however, and electron microscopy is thus applied to samples taken on polycarbonate membranes. Especially CCSEM analyses can provide valuable information about the chemical composition of a high number of single particles.

Taking these special capacities and possibilities of each combination of sampling and analytical methods into consideration the following methodology seems to be most suitable to investigate the relevant properties of fly-ashes and aerosols formed during biomass combustion:

Simultaneous BLPI and total dust measurements should be carried out at sampling boards directly behind the boiler outlet. The samples of the total dust measurement

are then forwarded for wet chemical analyses. Small sections of the BLPI foils are cut off and forwarded for electron microscopy while the remaining part is analysed using wet chemical methods. Additionally, samples with polycarbonate filters should be taken at the same sampling location and also forwarded for SEM, SEM-EDX and CCSEM analyses. By using the different analytical methods presented in this paper and carefully comparing and evaluating the results (taking the advantages and disadvantages of the individual methods into consideration), comprehensive information about the main characteristics of particulates can be achieved.

ACKNOWLEDGMENTS

The project this paper is related to is sponsored by the Austrian Science Fund (FWF) under contract P13714-TEC "Behaviour of ash-forming compounds in biomass furnaces".

REFERENCES

- [1] OBERNBERGER I., BRUNNER T., DAHL J., (1999): Formation, Composition and Particle Size Distribution of Fly Ashes from Biomass Combustion Plants. In: Proceedings of the 4th Biomass Conference of the Americas, Sept 1999, Oakland (California), USA, ISBN 0 08 043019 8, Elsevier Science Ltd. (Ed.), Oxford, UK, pp. 1377-1385
- [2] OBERNBERGER I., PÖLT P., PANHOLZER F., (1994): Charakterisierung von Holzrasche aus Biomasseheizwerken, Teil I: Zur chemischen Analytik der Aschefractionen. Umweltwissen-schaften und Schadstoff-Forschung - Zeitschrift für Umweltchemie und Ökotoxikologie, Heft 6 (1994)
- [3] OBERNBERGER I., DAHL J., ARICH A., (1998): Biomass fuel and ash analysis, report of the European Commission, ISBN 92-828-3257-0, European Commission DG XII (ed), Brussels, Belgium
- [4] PANHOLZER F., (1996): Homogenisation, Digestion and Analysis of Biomass Fuels and Ashes. In Minutes of the IEA Activity Meeting of TASK XIII, Activity 6, Sept 1995, Graz, Austria. New Zealand Forest Research Institute (Ed), Rotorua, New Zealand
- [5] BRUNNER T., DAHL J., OBERNBERGER I., PÖLT P., 2000: Chemical and structural analyses of aerosols and fly ashes from biomass combustion units by electron microscopy. In: Proceedings of the 1st World Conference on Biomass for Energy and Industry, June 2000, Sevilla, Spain
- [6] POELT P., SCHMIED M., BRUNNER T., 2000: Automated Analysis of Submicron Particles in SEM, Proceedings of the 12th European Congress on Electron Microscopy, July 9-14, 2000, Brno, Czech Republic
- [7] DAHL J., 2000: Chemistry and behaviour of environmentally relevant heavy metals in biomass combustion and thermal ash treatment processes, PhD Thesis, Institute of Chemical Engineering Fundamentals and Plant Engineering, University of Technology Graz, Austria

FIELD INVESTIGATION OF NANOPARTICLE EMISSIONS FROM VARIOUS BIOMASS COMBUSTION SYSTEMS

Ch. Gaegauf, U. Wieser, Y. Macquat

Center of Appropriate Technology and Social Ecology,
Schwengstrasse 12, CH-4438 Langenbruck, Switzerland
phone +41/(0)62 387 31 11, fax +41/(0)62 390 16 40, admin@oekozentrum.ch, www.oekozentrum.ch

ABSTRACT: Wood combustion processes produce smoke emissions, that are of concern to authorities and the public. Recent European studies claim airborne particulate matter (PM) smaller than 10 μm (PM10) as major respiratory irritants (*Air pollution and Health*, EC-APHEA I and II). The Swiss Federal Environment Protection Agency is acquiring emission factors on PM pollutants of various sources in order to establish strategies for aerosol abatement. The work carried out by the *Center of Appropriate Technology and Social Ecology* covered the investigations of typical wood fuel combustion systems in the field under real world conditions. This to cope with the lack of quantified PM emission factors and characterization in terms of particle numbers and size distribution.

Two analytical methods were used to monitor PM emissions. A *Scanning Mobility Particle Sizer* (SMPS) was utilized to determine nanoparticle numbers and size distribution in wood combustion stack gases with a mobility diameter from 0.015 up to 0.6 μm (PM0.6). *Total Suspended Particles* (TSP) were measured simultaneously to compare TSP with the emissions of PM0.6, calculated from the SMPS-analysis.

Totally 14 different wood combustion systems were tested including room heating appliances, wood log and automatic fed boilers. The wood based fuel comprised logs, chips and pellets. It could be shown that the major part of the particle sizes is in the range of 30 to 300 nm. Particles >300 nm do not add substantially to the total emission rate in the flue gases. The particle distribution of manual operated appliances is quite varying during a burn cycle, while wood log and continuous fed boilers show a fairly constant particle size distribution. The minimum emission factor of total particle number (TNPM0.6) of the different combustion systems was found in the range of approximately 1:3.8, where as the maximum was widely spread. The TSP emission factors correspond fairly well with the TSP figures calculated from SMPS data if there were little products of incomplete combustion (PIC) and no high grate vent entraining ash. The data resulting from these investigations allows prediction of the PM on a particular airshed of a population of different wood combustion systems.

Keywords: wood combustion, particulate matter, emission factor, field measurement

1. INTRODUCTION

There is a growing interest for biomass fuels to cover a larger part of the required energy supply. Solid fuel burning combustion systems produce smoke emission, which are of concern to authorities and the public. Recent European studies claim airborne particulate matter (PM) smaller than 10 μm (PM10) as major respiratory irritants (*Air pollution and Health*, EC-APHEA I and II). Because of the small size of the particles (typically of the order of 1 micron and less) they easily pass through the nose and throat into the lungs [1]. The Swiss clean air act limits on air quality in form of limits on the suspended particulate matter (PM10) allowed in the atmosphere. In turn, authorities use these regulations to place limits on airborne particulate matter allowed from emissions sources in areas, which suffers from air pollution. The Swiss Federal Environment Protection Agency requires emission factors on PM pollutants of various sources in order to establish strategies for aerosol abatement. Several research institutes are presently investigating nanoparticle emissions from traffic such as vehicles or railroad.

Nanoparticle emissions from wood burning processes have not yet been measured under real world operating conditions, although these particle fractions can be relevant for health reasons in local areas.

2. OBJECTIVES

The work carried out by the *Laboratories for Sustainable Energy Systems* at the Center of Appropriate Technology and Social Ecology covered the investigation of typical wood fuel combustion systems in the field under real world conditions. The aim was to quantify PM emission factors and characterization in terms of particle numbers and size distribution in order to cope with the lack PM emission data.

The following wood combustion system were tested:

- Batch-wise fired appliances with manual refueling of wood logs comprising room heaters (2) and heat accumulating stoves (2).

- Batch-wise fired boilers with manual refueling of wood logs (2).
- Automatically fired wood pellet burners as boilers (2) and as room heater (1).
- Automatically fed wood chip burner with stoker (2), movable grate (2) and a gasifier (1).

3. EXPERIMENTAL

3.1 Total suspended particles (TSP)

The method to measure *total suspended particles* (TSP) was in accordance with the ISO/DIS 13336 [2] applying disk filters (figure 1).

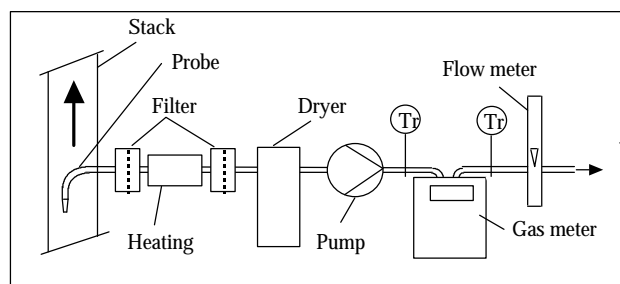

Figure 1: Equipment for the measurement of *total suspended particles* (TSP) according to ISO/DIS 13336 [2].

The particle mass was determined by gravimetric analysis of the dried filters.

3.2 Nanoparticle analysis

A *scanning mobility particle sizer* (SMPS) was applied to analyze nanoparticles [3]. *Size distribution* and *total number concentration* (TNC) of particles were determined in the range of 0.01-0.600 μm by analyzing the particle mobility diameter. An impactor with a cut-off size of 0.600 was used to withdraw the coarse particle fractions. Exhaust gases were taken with a probe, which was also fed with particle free air. The resulting dilution factor was adjusted by the flow rate of the diluting air and the total flow. To prevent condensation of water onto the particle surface, the dilution factor was chosen high enough, to achieve a dew point below ambient temperature. The analytical set-up is shown in figure 2.

The polydisperse aerosol particles in the sample gas passed through a radioactive bipolar charger, establishing a bipolar equilibrium on the particles. The particles then entered the *differential mobility analyzer* (DMA, TSI 3071) and were separated according to their electric mobility. A subsequent *condensation particle counter* (CPC, TSI 3025) evaluated the number concentration of the monodisperse aerosol particles. The number size distribution was measured by varying the DMA voltage over the measuring range and by recording the accompanying particle concentrations with the CPC. This scanning method was controlled by computer software.

The characteristic data of particles are given by the *mode diameter* (MD) as the most frequent size of a particle population and the *total number concentration* (TNC) as

the total amount of particles over the whole measured range.

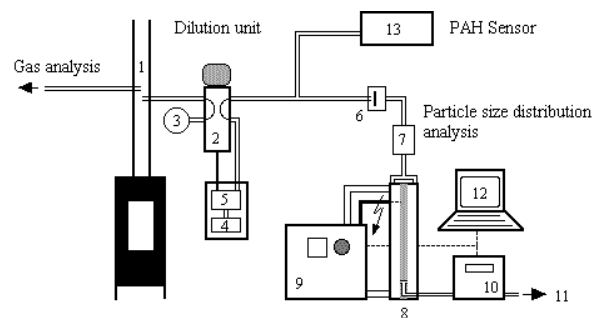

Legend

- | | |
|---|--------------------------------------|
| 1 Flue duct | 7 Radioactive neutralizer |
| 2 Rotating disc dilution unit | 8 Differential mobility analyzer DMA |
| 3 Exhaust gas pump | 9 Controller unit |
| 4 Particle filter | 10 Condensed particle counter CPC |
| 5 Flow & dilution controller | 11 Vacuum pump for sample flow |
| 6 Impactor, cut-off at dp 0.5 μm | 12 Size distribution analysis |
| | 13 PAH sensor |

Figure 2: Analysis of nanoparticles with *scanning mobility particle sizer* (SMPS).

The particle distribution graphs are done as commonly used in aerosol measurement: the channel width, which represents *particle diameter* (dp) range, is plotted on a logarithmic scale against the *total number concentration* (TNC), that is calculated from the measured number of particles (dN) divided by the logarithm of the channel width ($d\log(dp)$), where dp is the mobility diameter.

3.3 Test environment

The wood log and automatically fed boilers were tested on site. The room heating appliances were tested at the *Laboratories of Sustainable Energy Systems*. The lab infrastructure eases repeatable test conditions by applying accurate platform scale to measure the burn cycle of a wood log batch.

3.4 Wood combustion systems

The tested wood combustion systems had following technical specifications:

- *Roomheaters, batch-wise fired with wood logs:*
Two different designed appliances were tested. One appliance was a cast iron construction (**A**) the other was a welded construction (**7**). Both had a door with glazing for a visible flame.
- *Heat accumulating stoves:*
Two heat accumulating appliances were tested: one appliance was made from tiled masonry (**8**) the other from soapstone (**B**).
- *Wood log fired boilers:*
Two different boilers with a heat output of 25 kW (**5**) and 70 kW (**6**) were tested. The logs were air dried with a water content of 20 % (b.d.).
- *Wood pellet burners with mechanical feed:*
Two different boilers with a heat output of 17 kW (**C**) and 25 kW (**9**) were tested. A pellet fed appliance for room heating with heat output of 10 kW (**10**) was also investigated.
- *Wood chip burners with mechanical feed (stoker type):*
Two mechanical fed boilers were measured with

70 kW (D) and 200 kW (1) heat output for dry chips with a water content of 30 % (b.d.).

- *Wood chip burners (moving grate) with mechanical feed:*
Two boilers were tested with a heat output of 325 kW (2) and 800 kW (3) for green chips with a water content of 54 and 65 % (b.d.).
- *Wood burner (gasifier) with mechanical feed:*
The boiler was connected to a gasifier to burn wood residuals of a saw mill (4) The heat output was in the range of 200 kW. The residues were dry with a water content of 10 % (b.d.).

3.5 Test procedure

The TSP and particle size measurements were done simultaneously in the stack. The measurements at the appliances were done over several burn cycles. The test period of the *batch-wise burning appliance* commenced with the refueling of a new batch to the ember. When the platform scale read the initial weight the test cycle was stopped.

The test period of the *heat accumulating stove* started with the ignition of the fuel. The particle sampling ended when the carbon dioxide in the flue gas was below 2.5 Vol%.

The burn cycle of the wood log boilers lasted several hours. Different Samples were taken over one burn cycle. The mechanically fed boilers were tested over their various operating cycles like full load, part load and ember phase with no load.

4. RESULTS

The particle number distribution of the batch wise fired appliances are varying quite during the burn cycle. A typical particle distribution over a burn cycle is shown in figure 3. The start-up phase shows large particles with a mode diameter of 200 nm. In the phase where the stove is in its full operation, there is a slight decrease of particle number concentration. In the burn-out phase the particle size is increasing again to mode diameter of about 30 nm.

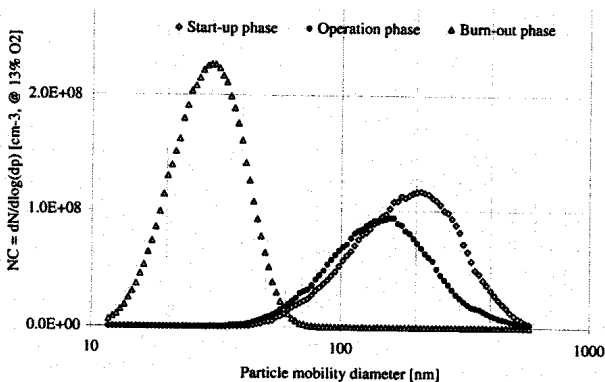

Figure 3: Typical particle size distribution over a burn cycle of a batch wise fired appliance (7).

The particle number distribution of wood log and automatic fired boilers are much more even over their

burn cycles. A typical particle size distribution is shown in figure 4 (pellet boiler C).

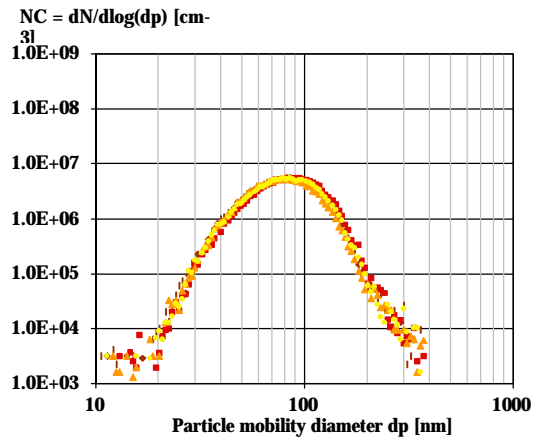

Figure 4: Typical particle size distribution of a pellet boiler (C) at nominal heat output.

The total emissions rate of particle fraction < 600 nm can be estimated from SMPS-data assuming spherical particles and an estimated density of 1500 kg/m³. The particle mass fractions and the accumulated particle mass are shown in figure 5. The graph of the accumulated particle mass flats out at 200 nm. It can be concluded that particles above 300 nm do not add substantially to the total particle emission rate.

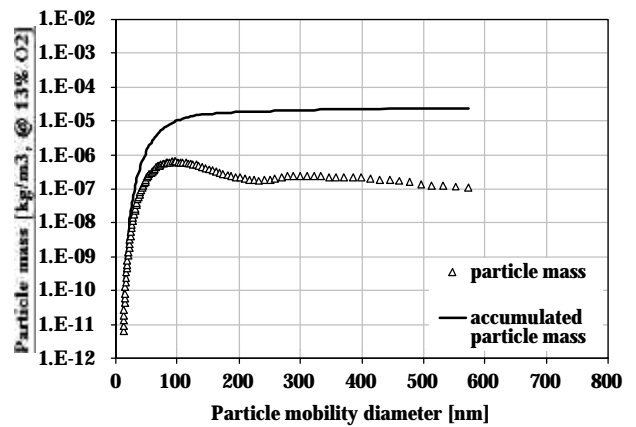

Figure 5: Pellets boiler (9): Particle mass in each fraction and accumulated particle mass over all fractions assuming particle shape as spheres with a density of 1500 kg/m³.

The effect of excess air on the particle formation was investigated for a wood chip boiler. The results are shown in figure 6. Not only the number of particles depends on the oxygen content, but also the mode diameter. At lower oxygen content fewer particles are formed. The most frequent diameter changes from approx. 60 nm at 11.6 % O₂ to approx. 90 nm at 2.7 % O₂.

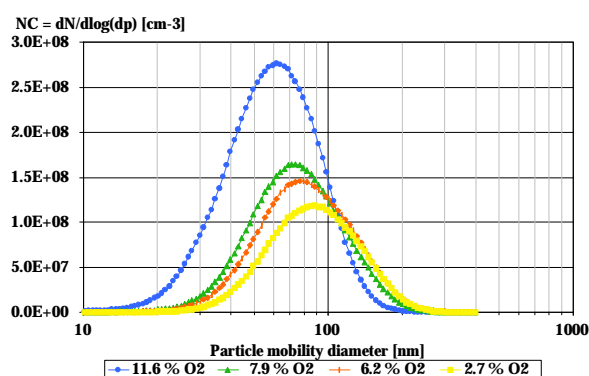

Figure 6: Particle number concentration as function of excess air (Wood chip boiler **D**).

The results of the investigations are summarized in Table 1. The emission factors are based on the net heating value of the fuel.

Table 1: Summary of particle measurements

Method	Total suspended particles		Nanoparticles < 600 nm	
	TSP		PM0.6	
	Disk filter		SMPS	
	TSP-Emission ¹⁾	Emission factor ²⁾	Emission factor ²⁾	TN- emission factor ²⁾
	[mg/m ³]	[mg/MJ]	[mg/MJ]	[#/MJ]
<i>Roomheating appliances</i>				
Roomheaters	99 ± 60	70 ± 25	161 ± 29	5.4 ± 1.5 E13
Accumulating stoves	247	167 ± 44	569 ± 309	15.4 ± 6 E13
<i>Wood log boilers</i>				
Boilers	42 ± 17	28 ± 11	12 ± 6	6.0 ± 2 E13
<i>Pellet burners</i>				
Boilers	29 ± 0.5	20 ± 0.4	14 ± 2	2.7 ± 0.2 E13
Roomheater	80 ± 4	54 ± 3	164 ± 105	8.6 ± 2.2 E13
<i>Wood chip boilers</i>				
dry fuel	140 ± 32	94 ± 13	45 ± 1	9.2 ± 0.9 E13
wet fuel	67 ± 8	48 ± 6	39 ± 12	4.9 ± 0.5 E13
residuals	96 ± 11	64 ± 7	59 ± 12	8.2 ± 0.7 E13

¹⁾ based on 13 % oxygen

²⁾ based on net heating value

The emission factors of the TSP-values measured by flat filter method and the total number emission factors of PM0.6-emission factors by SMPS are compared in figure 7. There is similar tendency of TSP emission factors and the total number emission factors. Looking at the individual examples one can see though significant deviations of the correlation between the two values such as high PM0.6 figures and low TSP (e.g. boiler 5) and the reverse case (e.g. appliance 7).

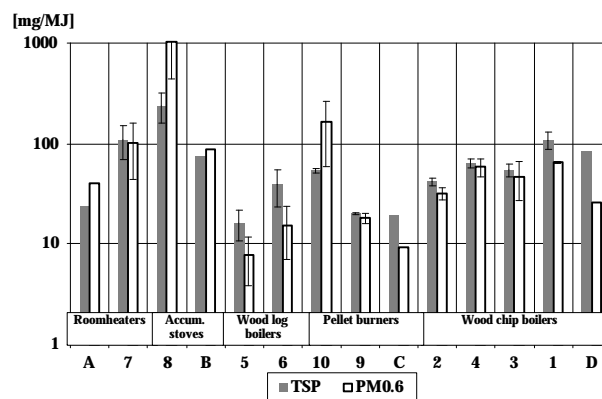

Figure 7: TSP emission factors based on fuel net heating value and PM0.6 total number emission factors, received from SMPS-data.

5. CONCLUSIONS

- The resulting data from these investigations allow prediction of the particulate matter emissions on a particular airshed of a population of different wood combustion systems.
- The results show that the major part of the particle emissions (up to 95%) are smaller than 0.4 μm .
- The particle size in the exhausts of wood fired appliances is in the range of 30 to 200 nm. The range of wood log or automatically fired boilers lays between 70 to 90 nm.
- The most frequent size of the particle number concentrations for batch operated appliances can go up to 200 nm, whereas the particle distribution changes quite a lot during the burn cycle. The particle size distribution for wood log and mechanically fed boilers remains constant and shows a most frequent size of the particle number concentrations of approx. 80 nm.
- The minimum PM0.6-emission factors of total particle number of all categories spread about 1:3.8 (2.5 ÷ 9.4 E13 #/MJ). The maximum thus varies widely.
- There is an influence of operating parameter to particulate emission. The variation of particle numbers due to excess air variation is $\pm 40\%$.
- One can estimate the particle emission rate from SMPS data with the particle number concentrations of the fractions based on some assumptions such as particle geometry and density.
- The TSP emission factors correspond fairly with the PM0.6-emission factors calculated from SMPS data if there were little products of incomplete combustion (PIC) and no high grate vent entraining ash.
- The particle size distribution graph allows a quick qualitative judgement of smoke emissions.
- It can be concluded that the SMPS method is a feasible on-line method to analyze nanoparticles from wood combustion processes under real operating conditions.

ACKNOWLEDGMENTS

The Swiss Federal Environment Protection Agency (BUWAL) funded the investigations together with air pollution control offices of several Swiss cantons.

REFERENCES

- [1] Non-Biological Particles and Health, Committee on the Medical, Effects of Air Pollutants, HMSO Publication, (1995), London
- [2] ISO/DIS 13336, Draft International Standard (DIS), Solid fuel burning appliances - Test method for determining power output, efficiency and flue gas emissions, International Organization for Standardization (1997)
- [3] Hüglin C., Gaegauf C., Kuenzel S., Burtscher H., Characterization of Wood Combustion Particles. Morphology, Mobility and Photoelectric Activity, Environmental Science and Technology, 31, p. 3439-3447 (1997)

PARTICULATE EMISSIONS FROM SMALL-SCALE BIOMASS COMBUSTION

L. Johansson¹, C. Tullin¹, B. Leckner²

¹SP Swedish National Testing and Research Institute, Box 857, SE – 501 15 Borås, Sweden

Phone +46 (0)33 16 50 00, fax +46 (0)33 13 19 79, email: linda.johansson@sp.se

²Chalmers University of Technology, SE – 412 96 Göteborg, Sweden

ABSTRACT: An increased use of small-scale biomass combustion can result in higher ambient concentrations of particulate matter. The objective with this investigation is to characterise the emissions of particulates as well as gases from smaller district heating plants (2-3 MW) where the particle separation is limited to cyclones. The particle measurements were performed downstream the cyclones. The particle number size distributions were found to be dominated by submicron particles with peaks in the size range of 0.1-0.3 μm . The dust emissions were in the range of 60-200 mg/m_n^3 at 13% CO_2 . The number concentrations during normal operation are 10^7 per cm^3 . The influence of load, excess air and fuel quality is discussed. In addition, results are reported for gaseous pollutants, i.e. CO/CO_2 , THC (total hydrocarbons), CH_4 (methane), C_2H_4 (ethene), NO_x and NH_3 (ammonia).

Keywords: district-heating boiler, biomass, small-scale, particulate emissions, particle size distribution, gas emissions

1. INTRODUCTION

In recent years, negative health effects of even low levels of PM_{10} and $\text{PM}_{2.5}$ (particulate matter with particle sizes smaller or equal to 10 and 2.5 μm respectively) in the ambient air have been observed [1], [2]. Different kinds of combustion devices like internal combustion engines, heat and power plants, as well as small-scale wood-fired boilers are examples of sources of the particulate emissions. Particulate matter generated from combustion, factors governing particle size and composition, and implications to human health have been discussed recently in a critical review [3]. Particle surface area, number of ultrafine particles, metals, and particle-bound organic compounds like polycyclic aromatic hydrocarbons (PAH) are suspected to be more important than particle mass in determining the health effects of air pollution.

Normally, in Sweden, the mass concentration of the particulate emission is called dust. The knowledge of the chemical and physical characteristics, for instance the particle size distribution, of the particulate matter from biomass combustion is limited, as well as the effect of different combustion parameters and fuel quality. Moreover, for small-scale biomass combustion (domestic scale boilers and smaller district heating plants) data regarding the total particulate emissions are limited. As the use of small-scale biomass combustion is increasing, there is a need to carefully characterise the emissions of particulates from these units, quantitatively as well as qualitatively.

Small-scale biomass combustion includes combustion devices of different sizes. The smallest ones are stoves and boilers with a thermal output of 10-15 kW for domestic use. These stoves normally have no particle cleaning device and the particulate emission range is wide. Direct fired domestic boilers (i.e. boilers that are not combined with a heat storage tank) sometimes show emission levels higher than 1000 mg dust/MJ supplied fuel [4] while modern “state-of-the-art” boilers and stoves can show dust emissions of less than 10 mg dust/MJ supplied fuel. Small-scale biomass district-heating plants usually have a cyclone or multicyclone as a particle cleaning device. The emission levels vary but are in general in the magnitude of 100 mg per dry normal cubic meter flue gas at 13% CO_2 or higher [5] (100 mg per dry normal cubic meter flue gas at 13% CO_2 corresponds to 34 mg dust/MJ supplied fuel). Finally, outside of the scope of the present investigation, there are larger boilers equipped with efficient gas cleaning devices, such as bag filters or electrostatic precipitators.

The objective with this study is to measure and characterise gas, dust and particulate emissions from small-scale boilers. The particulate emissions will be analysed both as conventional dust measurements and as number concentrations and particle size distributions. Conventional dust measurements define the emission status of the plant whereas measurements of number concentrations and particle size distributions yields information of interest with respect to health aspects.

In this presentation, results of emission measurements from two district-heating plants with a thermal output of

about 2-3 MW are reported. The fuels studied are wood pellets and wood briquettes of different densities. The particle measurements were performed downstream the cyclones. In addition to detailed particulate emissions, the flue gas was analysed for O₂, CO, CO₂, THC (total hydrocarbons), CH₄ (methane), C₂H₄ (ethene), NO_x and NH₃ (ammonia). The influence of load, excess air and fuel qualities is discussed.

2. EXPERIMENTAL

2.1 Boilers

The boilers studied in this investigation were located close to Borås in Sweden, i.e. in Sandared and Fristad. Both boilers are delivered by Teem Bioenergi AB and are of the same construction principle. The boilers are equipped with fixed grates with moving scrapes. For dust removal multicyclones are used. The Sandared boiler has a thermal output of 1.75 MW and is fired with wood pellets. It is normally operated at full load and at an excess air corresponding to 9% O₂ in the flue gas. The Fristad boiler has a thermal output of 2.50 MW and is fired with wood briquettes. It is normally operated at full load and at an excess air corresponding to 6% O₂ in the flue gas.

2.2 Fuels

The analyses of the fuels are shown in Table 2.1. At the district heating plant in Sandared wood pellets were fired. It is a refined and relatively homogenous biofuel with low moisture content. A wood pellet is a cylindrical particle. The diameter and length of the pellets used in Sandared were 8 mm and 15-20 mm, respectively. For the tests in Sandared, pellets of different densities were produced from the same raw material by Svensk Brikettenergi in Ulricehamn (Table 2.2).

The boiler in Fristad is fired with wood briquettes (Table 2.1). The diameter and length of the briquettes were 75 mm and 50-100 mm, respectively. Briquettes of normal and low density were fired. Low density briquettes disintegrate more easily thus generating more fines, which affect the combustion conditions.

Table 2.1. Fuel analysis of the reference pellets and briquettes. The numbers (except moisture) refer to dry matter.

	Wood pellets	Wood briquettes
Moisture (wt-%)	7.7	8.8
Heating value (MJ/kg)	20.4	20.2
Ashes (wt-%)	0.3	0.3
Sulphur (wt-%wt-%)	< 0.01	< 0.01
Carbon (wt-%)	50.6	49.9
Hydrogen (wt-%)	6.0	6.2
Nitrogen (wt-%)	0.08	0.09
Oxygen (wt-%)	43.1	43.4

Table 2.2. The densities for the different fuels.

Fuel	Bulk density (kg/m ³)	Piece density (kg/m ³)
Low density pellets	530	1090
Reference pellets	700	1200
Low density briquettes	380	-
Reference briquettes	480	930

2.3 Measurement equipment

The gas and particle sampling were performed in the flue-gas path downstream the cyclone with the measurement set-up presented in Figure 2.1. As seen from the figure, there are three heated sampling lines, i.e. for gas, dust and for particle number and size analyses. The dashed lines indicate heating to a temperature of 180 °C.

The gas concentrations of CO/CO₂, O₂, NO_x and THC (total hydrocarbons) were continuously measured with conventional instruments. Methane (CH₄), ethene (C₂H₄) and ammonia (NH₃), were analysed by FTIR (Fourier Transform Infrared Spectroscopy).

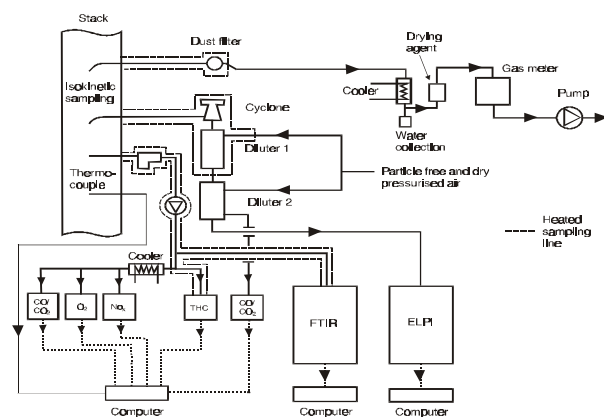

Figure 2.1. Measurement set-up during field measurements.

Dust, that is, the mass of particulate emission, was collected by isokinetic sampling and analysed gravimetrically. The dust was collected on a filter that was weighed before and after collecting dust. The moisture content of the flue gas was also determined gravimetrically by cooling and drying the gas. The precipitated water was then weighted and the weight increase of the drying agent was also registered. The fine particles originating from combustion are sampled isokinetically through a separate sampling line. The flue gas is then extracted and diluted in two steps. Two-stage dilution is applied to preserve the gas and particle conditions as much as possible. The flue gas is extracted through a heated probe and then passes a heated cyclone. Thereafter it enters the first diluter, which is also heated. Thereafter it enters the second diluter, which is also heated. The second dilution is performed at room temperature. The dilution system is a two-stage ejector based diluting system and gives a dilution ratio of 1:50.

Particle number concentrations and number size distributions, in the size range of 30 nm to 10 µm, were continuously measured using an ELPI (Electrical Low Pressure Impactor). Consequently the particle sizes are measured as aerodynamic diameters.

Table 2.3. Measurement uncertainties.

Measurement uncertainty	
O ₂	±0.2 %
CO ₂	±0.2 %
CO	±50 ppm
NO _x	±5 ppm
THC	±10 ppm
NH ₃	±20%
CH ₄	±20%
C ₂ H ₄	±20%
Dust	±10%

3. RESULTS

3.1 Sandared boiler

In Table 3.1 and Figure 3.1-3.3, the results from the particulate measurements in the Sandared boiler are summarised and in Table 3.2 the gas emissions are presented. The results from the reference case are indicated by extra bold type in the tables. The measured dust emissions (mass of particulate emissions) were in the range 20-50 mg/MJ. The emissions of PM₁₀, expressed as number of particles per MJ fuel supplied, increase slightly when raising the boiler load. The particle number concentrations were in the range 1.5 *10¹¹ 1/MJ – 2.9 *10¹¹ 1/MJ.

The density of the wood pellets was found to affect the emissions. The measurements show an increase of the CO emission when firing pellets of low density. Also, the dust emission (mg per MJ fuel supplied) is higher during combustion of the low-density pellets than with the reference density pellets. Concerning number concentrations no clear tendencies are observed. Planning these measurements there was an intention to fire pellets of three different densities. However, the high-density pellets turned out to be of the same density as the reference pellets. The pellets that were intended to have a higher density are called “ref. density 2” in Table 3.1 and Figure 3.3. Comparing the measurements for the reference density pellets and the reference density 2 pellets show that there is a good repeatability between the tests concerning both gas and particulate emissions. The lower dust emission value for the reference density, 2 pellets can be an effect of a higher pellet quality (with respect to disintegration) although it was not observed as a higher density.

Table 3.1. Summary of the dust and particulate measurements at the boiler in Sandared.

Planned operation	Measured ¹	PM ₁₀ 1/MJ	Dust mg/MJ
	O ₂ %		
20% load, 4% O ₂	7.5	1.6E+11	43
20% load, 7% O ₂	8.5	1.5E+11	49
20% load, 9% O ₂	9.9	1.7E+11	35
50% load, 4% O ₂	4.7	2.9E+11	33
50% load, 7% O ₂	7.4	3.2E+11	43
50% load, 9% O ₂	9.2	3.4E+11	32
100% load, 4% O ₂	3.7	3.4E+11	32
100% load, 7% O ₂	6.8	3.5E+11	22
100% load, 9% O₂²	8.9	5.8E+11	35
100% load, 9% O ₂ low density pellets	9.3	5.9E+11	38
100 % load, 9% O ₂ ref. density 2 pellets	9.5	5.4E+11	27

¹ The measured O₂-concentrations were considerable higher then the set values.

² Extra bolded type indicates the reference case, i.e. operation at normal conditions.

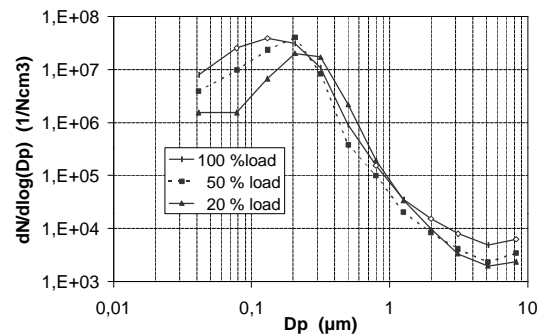
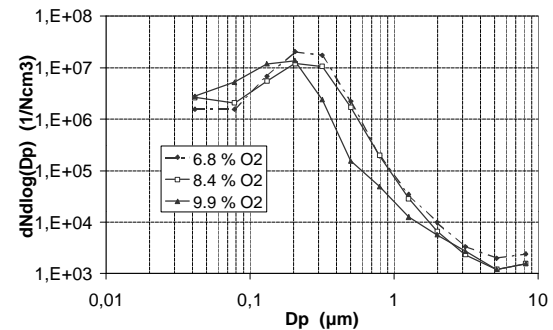

Figure 3.1. Number particle size distributions at different loads at the boiler in Sandared (the curves represent operation conditions near 7% O₂ and are normalised to 7% O₂).

Figure 3.2. Number particle size distributions at 20% load and different excess airs at the boiler in Sandared.



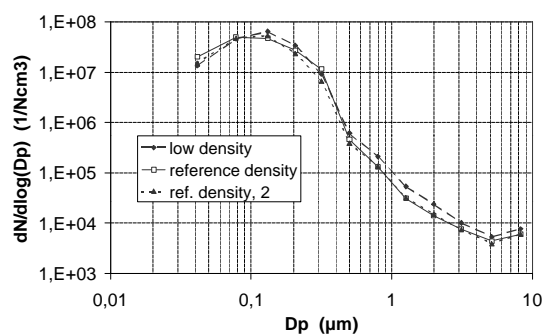

Figure 3.3. Number particle size distributions at different pellet densities at the boiler in Sandared. The distribution curves are normalised to 9% O₂.

The influence of load on particle number size distributions is shown in Figure 3.1. The particle number size distributions display peaks in the range of 0.1-0.3 µm. There is a tendency of a displacement of the peak to larger particle sizes as the load is decreased. In Figure 3.2 the influence of excess air on particle number size distribution is presented by showing number size distributions at three levels of excess air at a boiler load of 20%. The peaks of the number size distributions are found in the range of 0.1 to 0.3 µm. There is also a tendency of a displacement of the peak in the distribution to larger particle sizes when the excess air is lowered.

Table 3.2. Summary of the gas measurements at the boiler in Sandared.

load %	O ₂ %	CO mg/MJ	THC ¹ mg/MJ	CH ₄ mg/MJ	C ₂ H ₄ mg/MJ	NO _x ² mg/MJ	NH ₃ mg/MJ
20	7.5	7364	492	387	56	17	6
20	8.5	5646	213	147	9	24	4
20	9.9	45	2	<1	<1	25	<1
50	4.7	4484	106	69	5	26	3
50	7.4	1611	17	<1	1	27	1
50	9.2	505	9	<1	3	33	<1
100	3.7	142	<1	<1	1	37	<1
100	6.8	26	<1	<1	<1	36	<1
100³	8.9	21	<1	<1	3	39	<1
100	9.3	44	<1	<1	<1	39	<1
100	9.5	21	<1	<1	<1	38	<1

¹ THC (Total hydrocarbons) are represented as methane equivalents.

² NO_x is presented as mg NO₂/MJ fuel supplied.

³ Extra bolded type indicates the reference case, i.e. operation at normal conditions.

The emission of carbon monoxide at reference conditions, 100% load and 9% O₂, was 20 mg/MJ fuel supplied and the hydrocarbon emissions were insignificant. The emissions were low during normal operation, but the gaseous emissions (CO and hydrocarbons) increased substantially during operation conditions that deviated

from the normal one, that is, at low excess air and low load. At low load and low excess air, the emissions of hydrocarbons are enhanced. The largest part of the total emission of hydrocarbons is then methane. Also ethene is detected at low loads and low excess air.

The NO_x-emissions are in the range 20-40 mg/MJ, there is also a tendency of lower NO_x-emissions at low load and low air excesses. At reference conditions the NO_x-emissions are 40 mg/MJ. The ammonia emissions are low, but some ammonia is detected at low loads and low excess air.

3.2 Fristad boiler

In Table 3.3 and Figure 3.4-3.6, the results from the particulate measurements in the Fristad boiler are summarised and in Table 3.4 the gas emissions are presented. The results from the reference case are indicated by extra bold type. The dust emissions are in the range 20-70 mg/MJ fuel supplied. The dust emission in the reference case, i.e. 100% load and 7.5% O₂, was 40 mg/MJ. There is a trend of increasing dust emissions as excess air is increased. The emissions of PM₁₀, expressed as number of particles per MJ fuel supplied, increase when raising the boiler load. There is also a tendency of an increase of number of particles when increasing the excess air. The number concentrations were in the range 0.9 *10¹¹ 1/MJ – 11 *10¹¹ 1/MJ. In the reference case the emission of particles was 6.2 *10¹¹ 1/MJ. During the reference case the emissions of hydrocarbons are insignificant and the CO-emission is about 100 mg/MJ fuel supplied.

Briquettes of a low density contain a larger share of fine fraction than the reference briquettes. This might affect the combustion behaviour and consequently the emissions. There is an increase of the CO emission when firing pellets of low density. But the dust emission in mg per MJ fuel supplied is of the same magnitude. Concerning number concentrations one observes a decrease of the number concentration when firing low density briquettes.

Table 3.3. Summary of the dust and particulate measurements at the boiler in Fristad.

Planned operation	Measured O ₂ %	PM ₁₀ 1/MJ	Dust mg/MJ
20% load, 7% O ₂	9.6	0.9E+11	30
50% load, 7% O ₂	7.4	2.7E+11	21
100% load, 3% O ₂	3.9	4.2E+11	26
100% load, 5% O ₂	4.8	4.7E+11	29
100% load, 7% O₂¹	5.7	6.2E+11	40
100% load, 9% O ₂	7.5	10.7E+11	72
100% load, 7% O ₂	6.3	3.6E+11	36
low density briquettes			

¹ Extra bolded type indicates the reference case, i.e. operation at normal conditions.

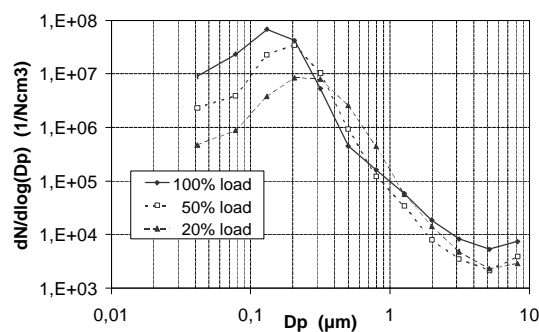

Figure 3.4. Number particle size distributions at different loads at the boiler in Fristad (the particle concentrations are normalised to 7% O₂).

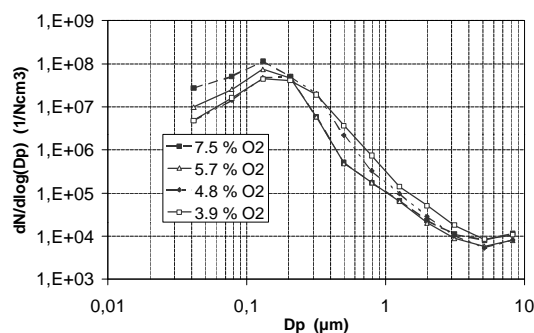

Figure 3.5. Number particle size distributions at 100% load and different excess airs at the boiler in Fristad.

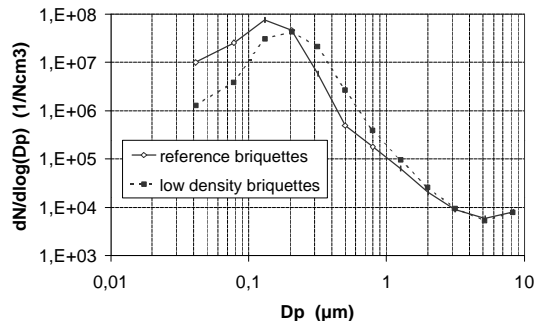

Figure 3.6. Number particle size distributions at different briquette densities at the boiler in Fristad.

The influence of load on particle number size distributions is shown in Figure 3.4. Also in this figure the particle number size distributions display peaks in the range of 0.1-0.3 µm. In Figure 3.5 the influence of excess air on particle number size distribution is presented by showing number size distributions at three levels of excess air at a boiler load of 20%. The peaks of the number size distributions are found in the range of particle diameter of 0.1 to 0.3 µm.

Table 3.4. Summary of the gas measurements at the boiler in Fristad.

load %	O ₂ %	CO mg/MJ	THC ¹ mg/MJ	CH ₄ mg/MJ	C ₂ H ₄ mg/MJ	NO _x ² mg/MJ	NH ₃ , mg/MJ
20	9.6	758	<1	<1	<1	33	<1
50	7.4	292	2	<1	<1	30	<1
100	3.9	265	3	4	<1	39	<1
100	4.8	107	<1	<1	<1	40	<1
100	5.7	95	<1	<1	<1	41	<1
100	7.5	133	3	<1	<1	47	<1
100	6.3	269	2	<1	<1	35	<1

¹ THC (Total hydrocarbons) are represented as methane equivalents.

² NO_x is presented as mg NO₂/MJ fuel supplied.

³ Extra bolded type indicates the reference case, i.e. operation at normal conditions.

The emissions of hydrocarbon are low in all cases. The emission of CO is in the range 100 mg/MJ at 100% load and O₂ concentrations of 4.8-7.5% and increases when lowering load, decreasing excess air to a minimum or firing low-density briquettes.

The emissions of ammonia are insignificant and the NO_x-emissions are in the range 30-50 mg/MJ. During reference conditions, i.e. 100% load and 6% O₂, the emissions of NO_x are 40 mg/MJ.

4. DISCUSSION

The dust emissions for the two investigated boilers were in the range 20-70 mg/MJ fuel supplied. At normal operation conditions (the reference cases), the emissions were 35-40 mg/MJ which corresponds to 100-120 mg/m_n³ at 13% CO₂. Previous reported emission levels from biofuel district heating plants of this size class are in the magnitude of 100 mg per dry normal cubic meter flue gas at 13% CO₂ or higher [5]. Thus these measurements represent typical smaller biofuel district heating plants.

The particle number concentrations here are presented as 1/MJ fuel supplied. At the reference cases in Sandared and Fristad this correspond to 3.1 *10⁷ and 3.2 *10⁷ number per cm_n³ (0 °C, 100 kPa) at 13% CO₂ respectively. The particle number concentrations show peaks in the range of 0.1-0.3 µm which is consistent with other studies of small-scale biomass combustion [6], [7]. According to Figures 3.1 and 3.4, there is some displacement of the peak of number size distribution towards larger particle diameter when reaching the lowest load of the boiler. Figures 3.2 and 3.5 also show a certain displacement of the peak towards larger particle diameter at lower excess air. The tendency of the number size distribution to attain a maximum at a larger particle size during low excess air and at low boiler load might for example indicate an influence of soot particles or a condensation of the flue gas. Similar results have been reported by Hueglin [Hueglin, 1997 #119 who found a tendency of peaks in the number distribution to occur at

larger particle sizes during unsatisfactory combustion conditions.

5. CONCLUSIONS

The boilers in Sandared and Fristad performed well during the tests. The emissions were low during normal operation, but the gaseous emissions (CO and hydrocarbons) increased substantially during operation conditions that deviated from the normal one, that is, at low excess air and low load. The number concentrations of particle emissions (PM₁₀) were low at low load and higher at high load. At the reference cases in Sandared and Fristad the number concentrations are $3.1 \cdot 10^7$ and $3.2 \cdot 10^7$ number per cm_n³ (0 °C, 100 kPa) at 13% CO₂ respectively. This correlate to 10^{11} 1/MJ – 10^{12} 1/MJ. The number particle size distributions have peaks in the range of 0.1-0.3 µm. The results of the particulate emissions presented are a set of first measurement data that need to be confirmed by more measurements on similar combustion devices. The influence of various fuel qualities and the effect of particle separation devices other than cyclones are of interest. Detailed analysis of the physical and chemical characteristics of the particles are needed.

ACKNOWLEDGMENTS

This study was funded by the Small-Scale Biomass Combustion Programme of the Swedish National Energy Administration, Värmeforsk and Borås Energi AB, which is gratefully acknowledged. Svensk Brikettenergi in Ulricehamn is also acknowledged for producing pellets with different densities

REFERENCES

1. Dockery, D.W., *et al.*, *An association between air pollution and mortality in six U. S. cities*. The New England Journal of Medicine, 1993. **329**(24): p. 1753-1759.
2. Pope, C.A., *et al.*, *Particulate Air Pollution as a Predictor of Mortality in a Prospective Study of U. S. Adults*. Journal of Respiratory and Critical Care Medicine, 1995. **151**: p. 669-674.
3. Lighty, J., J.M. Veranth, and A.F. Sarofim, *Combustion Aerosols: Factors Governing Their Size and Composition and Implications to Human Health*. Journal of the Air and Waste Management Association, 2000. **50**: p. 1565-1618.
4. Karlsson, M.-L., *Emissioner från valpannorlastförhållandets betydelse*. 1992, SP-rapport.
5. Naturvårdsverket, *Emissioner från små värmeanläggningar 0,5-10 MW*, . 1998.
6. Hueglin, C., *et al.*, *Characterization of wood combustion particles: Morphology, Mobility, and Photoelectric Activity*. Environmental Science & Technology, 1997. **31**(12): p. 3439-3447.
7. Wieser, U. and C.K. Gaegauf, *Nanoparticle Emissions of Wood Combustion Processes*, in *1st World Conference and Exhibition on Biomass for Energy and Industry*. 2000: Sevilla.

Fine Particle Emissions from Combustion in small wood fired Furnaces

Volker Schmatloch, Jürg Brenn

EMPA, Überlandstr. 129, CH - 8600 Dübendorf, Schweiz

ABSTRACT: Wood fired heating appliances have become more popular over the last few years. One reason for this is wood, being a renewable source of energy, may be helpful in order to reduce problems related to the greenhouse effect. On the other hand until recently, wood combustion tended to produce higher emissions compared to other heating appliances using gas or fuel oil. In the last few years, there have been significant improvements concerning the emission of wood fired furnaces, but there is still room for further improvements. Especially the particle emissions are considered to be a problem. This topic, however, is quite important as fine particle emissions have been of considerable interest as it has become obvious that air pollution by fine particles is closely related to health problems. Therefore it is important to know what is the actual contribution of wood combustion to the overall particle pollution of the ambient air and maybe to find a way to avoid high particle emissions.

We have investigated the emissions of several wood fired heating appliances in order to characterise the particle emission under various combustion conditions. We used a number of measurement techniques (SMSP, CPC, ELPI, gravimetrie) for the determination of particle concentration or size distribution.

For the appliances tested we found a typical particle size to be between 80 nm and 180 nm. Particle size as well as concentration change significantly at different phases of the combustion period of the appliances using logs of wood. We also found reasonable qualitative correlation between different measurement techniques.

Introduction

For some time there has been considerable interest in particle emissions of various sources because particles in ambient air are a possible cause for adverse health effects. This has been shown by several epidemiological studies that have served as an important argument for the introduction of new regulations ("PM10 immission limits"). Besides transportation and industry, domestic-heating appliances are another important group of anthropogenic sources.

Therefore we have started several projects at the EMPA dealing with investigations on particle emissions of vehicle engines as well as of oil and wood fired heating appliances. Some measurement techniques were applied throughout all of these projects in order to allow comparisons between those different emission sources.

Figure 1 shows an estimation of the relevance of small wood fired heating by comparing their emissions to those generated by traffic in Switzerland. The data are based on the BUWAL reports 255 [1] and 256 [2]. It is important to notice that the contribution of traffic refers to tail pipe emissions only. A more detailed estimation of the contribution of wood fired appliances (column 2) can be based on the statistics as published by the Swiss Federal Office of Energy [3] and the emission factors for heating appliances [4]. Thus, depending on the assumptions, it can be estimated, that particle emissions from small wood fired furnaces equal about 30% to 60% of the emissions from combustion engines. Therefore the emissions of wood fired appliances are not negligible. The contribution of wood combustion becomes even more important as a significant decrease of traffic related particle emissions was predicted [1]. On the other hand, wood fired heating appliances have become more and more popular over the last few years. Besides the wish to add comfort to a living room by installation of an open fire place, one reason for increasing popularity is the fact that biomass combustion is considered one way to tackle the "CO₂ problem". In

order to keep up the image of being an environment-friendly source of energy it is important to pay attention to the emissions produced by wood combustion.

The project presented here has dealt with wood fired appliances with a heat output in a range of up to 40 kW. We looked at several typical models in order to get an impression of the importance of small heating appliances as particle emission sources. Where possible, we also looked at the influence of various parameters or settings of the appliances.

The characterisation of particle emission sources is rather involved as not only mass concentrations are of interest but also number concentration, composition, morphology and other properties may play an important role. We have used several measurement methods in order to address different properties of the emitted particles.

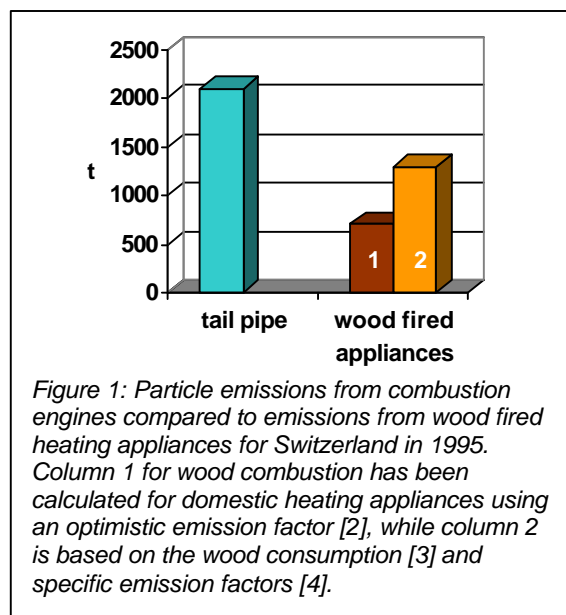

Figure 1: Particle emissions from combustion engines compared to emissions from wood fired heating appliances for Switzerland in 1995. Column 1 for wood combustion has been calculated for domestic heating appliances using an optimistic emission factor [2], while column 2 is based on the wood consumption [3] and specific emission factors [4].

Experimental

In this investigation we have performed measurements on two boilers and one open fireplace, all using logs of wood for fuel, and one boiler equipped with a pellet burner, see table 1.

Depending on the appliance, one load of wood lasted for two to four hours. The pellet burner, of course, was capable of continuous operation for more than two days. The "traditional" boiler 2 had the heat exchanger above the combustion chamber, while in the modern burner 1 the flame was turned upside down with the primary combustion air coming from above. This more elaborate design permits a more controlled combustion as well as a better heat exchange.

Figure 2 shows our experimental set-up which is arranged around the furnace. By an external heat exchanger we could control the water temperature and therefore extract a specific amount of heat from the system. We also could control the pressure at the flue gas exit of the boiler by means of an external fan. In the flue pipe we monitored temperature and pressure in the flue gas. We had a sampling line for gaseous emissions like CO or NO_x, and a port for extraction of samples for gravimetric measurements. Furthermore we had two lines for fine particle measurement. For the registration of fine particles with an electric low pressure impactor (ELPI) we used a straight sampling line to facilitate isokinetic extraction. According to its specifications, our ELPI can detect particle sizes from 50 nm to 10 µm. A time resolution of down to 10 s per spectrum may be reached. With the ELPI we used an injector diluter. On the second line, we had a rotary disk diluter which allows dilution ratios between 30 and 3000. Behind this diluter we could use a combination of two CPC and two DMA, giving us a measurement range of about 10 nm - 1 µm and a time resolution below 5 s for a fixed particle size. A complete spectrum of decent quality took at least 60 s by SMPS.

appliance	fuel	heat input / kW	comment
Boiler 1	logs of wood	41	modern, lambda controlled, fan assisted
Boiler 2	logs of wood	35	"traditional"
Boiler 3	wood pellet	17	automatic operation, lambda controlled, fan assisted
Open fireplace	logs of wood	6	-

Table 1: Appliances tested

Furthermore we could employ a thermodesorber in order to check for volatile particles or for volatile compounds on the particle surface. This is done by first passing the aerosol through a heated section where volatile substances evaporate. While still in the gaseous phase, these substances are captured by activated carbon in the water cooled section of the thermodesorber.

Results

The particle emissions from wood fired heating appliances vary significantly for different combustion conditions. Generally, more and much larger particles are emitted as compared to oil fired appliances. The maximum of the number size distribution typically was between 80 nm and 180 nm which is in agreement with other findings [5]. Figure 3 shows an example of number size distributions as measured with an ELPI. Figure 3 also hints at a general problem with furnaces fired by logs of wood. In general it is not possible to reproduce combustion conditions even in directly successive burning periods. The number size distributions in figure 3 each have been averaged over a complete burning period and therefore show a rather good agreement. The data have been recorded on the same appliance but on different days.

The more modern Boilers (1, 3) tended to produce slightly smaller particle sizes and did show smaller variations of particle size or number over time. Still, for all furnaces using logs of wood there were some problems running the ELPI measurements right from the ignition. Very often the nozzle of the injector diluter would clog. A possible explanation for these difficulties is that during the start of the fire a certain amount of particles much bigger than during the stationary phase of the burning period is emitted. With the available equipment there was no way to verify this explanation by experiments as, on one hand, ELPI measurements were not reliable when the clogging occurred. For gravimetric measurements, on the other hand, the critical phase was so short that no big impact on the total mass gathered on the filter

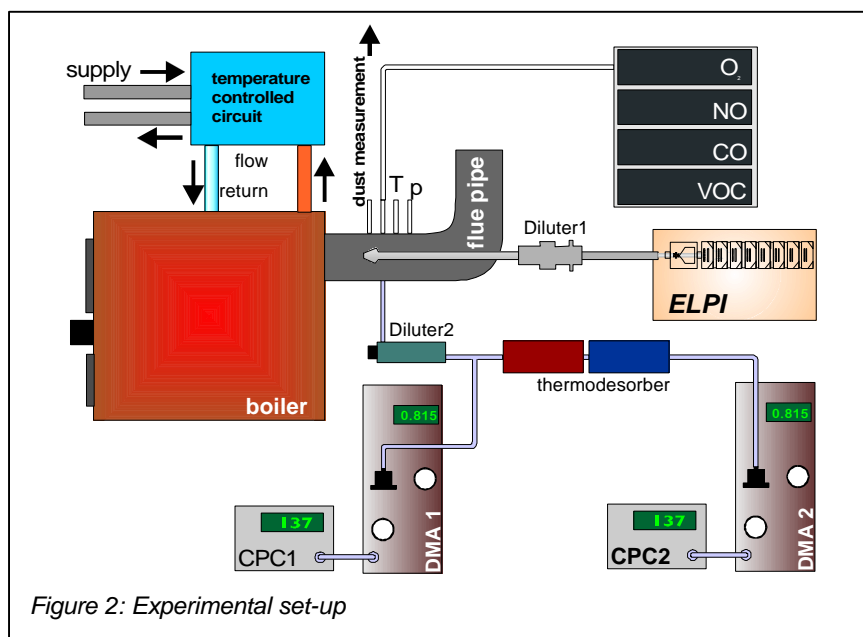

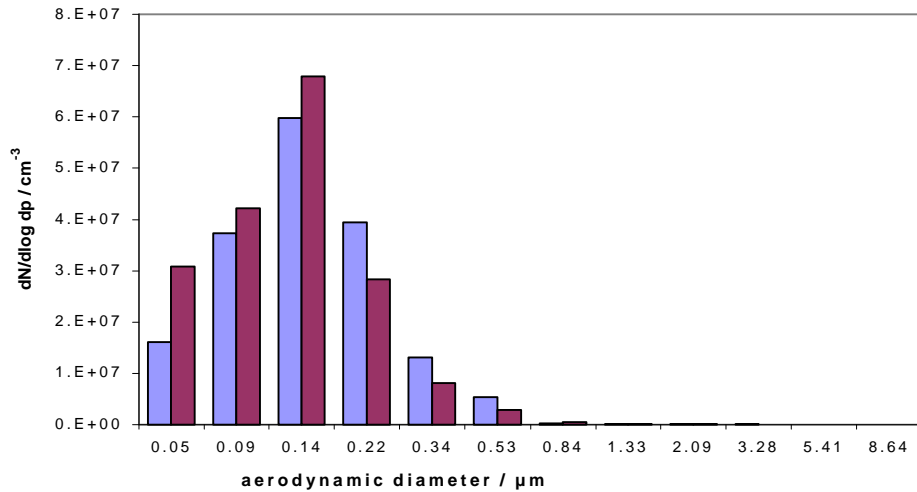

Figure 3: Particle number size distribution measured with an ELPI and averaged over a complete period. Two separate periods are compared.

could be expected.

Figure 4 gives a good impression of the increased particle emissions after the ignition. The initial peak cannot be observed with the gravimetric method as the sampling time for these measurements is too long. Apart from this, a rather good correlation between ELPI and gravimetric measurements is shown.

In figure 5 a detail near the end of one burning period of boiler 1 is shown. We have simultaneously measured gaseous components of the flue gas as well as particle emissions. CO is a quite reliable indicator for the quality of the combustion conditions. Figure 5 shows some coincidence between CO concentration and particle emissions. Sometimes even a closer relation has been observed.

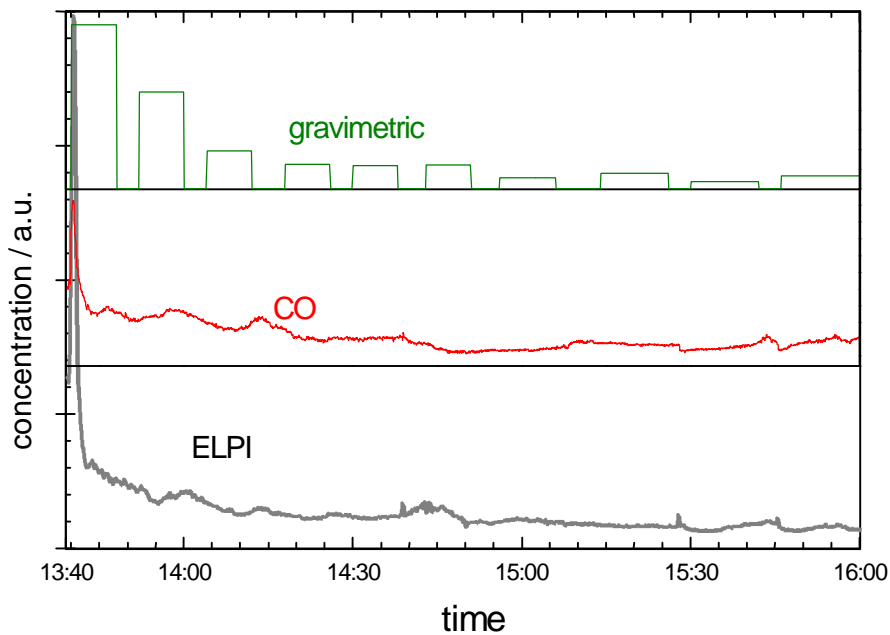
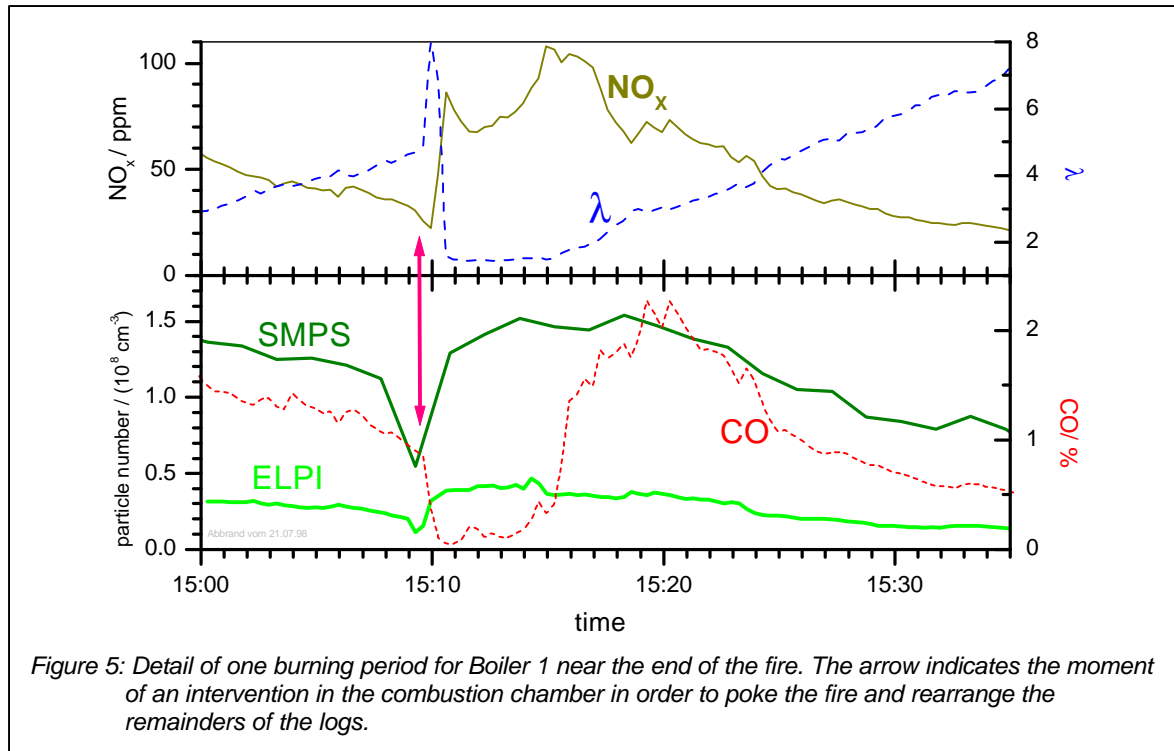

Figure 4: Particle mass concentration in the flue gas of the "traditional" Boiler.
 upper panel: gravimetric measurement
 middle: CO-concentration
 lower panel: particle mass according ELPI measurement

Note that the dramatic peak at the beginning of the burning period which can be observed with the ELPI is too short to be properly reflected in the gravimetric data. Apart from this, there is a satisfactory correlation between both methods.



After λ had increased steadily, the door to the combustion chamber had been opened for poking the fire and rearranging the remainders of the logs. This moment is indicated by the arrow in figure 5. After this intervention λ returned to a lower value for some minutes before the fire again started to go out. The figure also shows a qualitative agreement between ELPI and SMPS measurements.

Conclusion

We have observed the emissions of different kinds of heating appliances over complete combustion periods. The emissions vary significantly for different phases during such a period. Typical particle sizes are in the range of 80 nm to 180 nm. Different measurement techniques show qualitative agreement, while there are some quantitative differences that may be reduced by proper normalisation. But it has to be kept in mind that the different techniques assess quite different properties of the particles, for instance ELPI and SMPS use a different definition of the particle diameter. For a final evaluation, we intend to summarise the data in a way to allow an estimation of the emission factors for the appliances which we have tested.

ACKNOWLEDGMENT

The projects are funded by the Swiss Bundesamt für Umwelt, Wald und Landschaft (BUWAL).

REFERENCES

- [1] BUWAL: "Luftschadstoff-Emissionen des Strassenverkehrs 1950-2010", Schriftenreihe Umwelt Nr. 255, Bern 1995
- [2] BUWAL: "Vom Menschen verursachte Luftschadstoff-Emissionen in der Schweiz von 1990-2010", Schriftenreihe Umwelt Nr. 256, Bern 1995
- [3] BFE: "Schweizerische Holzenergiestatistik", 1998 (EDMZ-Nr. 805.520)
- [4] BUWAL: "Emissionsfaktoren für stationäre Quellen", Handbuch, Bern 1995
- [5] U. Wieser, Chr. Gaegauf, "Feld-Messkampagne – Partikelemissionen aus Holzfeuerungen", Bericht Feb. 2000, Ökozentrum Langenbruck

DISCUSSION AND CONCLUSIONS

Thomas Nussbaumer

Verenum, Langmauerstrasse 109, CH – 8006 Zurich, Switzerland
Phone +41 (0)1 364 14 12, fax +41 (0)1 364 14 12, email verenum@access.ch

1. TECHNICAL QUESTIONS

1.1 Number and mass distribution

Question to J. Jokiniemi:

How do you calculate from number distribution to mass distribution, what assumptions are needed and what is the accuracy?

Answer:

Calculation from number size to mass needs assumptions of density and shape. These informations are assumed from comparative measurements. The calculated data are regarded as uncertain and only used as indicative additional information.

1.2 Fundamentals

Questions to J. Jokiniemi and H. Livbjerg:

What are the reasons for the large differences in aerosols from fixed bed (almost no particulates > 1 micron) and fluidised bed combustion (large amount of particulates > 1 micron)? What is the composition/carbon content of particulates > 1 micron in fluidised bed?

Answer: Differences between fixed bed and fluidised bed is attributed to the different temperatures. Fluidised beds are operated at low temperatures (limited to 800°C) in comparison to grate combustion (1000°C), hence particulates with high carbon content are formed. Further bed material can lead to particulate emissions.

1.3 Composition of particulates

Question to T. Brunner: You found a decrease of K with increasing particle size. Which component is increasing? How is the sampling performed and what is the accuracy of measurements on composition for different fractions? Is the measurement of Si possible?

Answer: There is an increase of Ca with increasing size. The sampling is done with BLPI (Berner low pressure impactor), which enables 4 to 5 classes below 1 micron. The accuracy is reasonable, although for the smallest fraction the error of weighing becomes relevant. The mass for analysis is between 50 to 2000 micrograms. Only the analysis of Si is critical due to the low mass. Analyses were performed with SEM/EDX.

1.4 Fuel size

Question to C. Ehrlich:

Do you have an explanation for higher fines in the flue gas for lower fines in the fuel? What is meant by higher fines/lower fines in the fuel?

Answer:

Here high fines in the fuel means wood chips, low fines means log wood. The effect of higher fines for log wood is due to unburned particles.

Discussion: There is no correlation expected between fuel size and size of particulate emissions since the size ranges are different by several orders of magnitude.

2. CONCLUSIONS

2.1 Primary measures

Questions:

Which primary measures are available, potential? Which influences on aerosol formation should be investigated?

Obernberger: The fuel composition influences the particulate emissions, hence the choice of the fuel is important. For straw, bleaching in the rain is advantageous.

Nussbaumer: If the use of biomass for energy utilization will increase, the fuel quality will decrease and hence the possibilities of fuel choice seem to be limited.

Tullin: Pellet production can enable high combustion quality also in domestic furnaces.

Bühler: Gasification can be an alternative to combustion with lower particulate emissions.

2.2 Secondary measures

Question: What is the potential of secondary measures?

Nussbaumer: In Switzerland, fabric filters are regarded as promising thanks to high efficiency for fine particles and reduction of other pollutants. Electric precipitators show a low efficiency for particulates between 0.1 – 1 micron which may be a disadvantage.

Obernberger, others: Electrostatic precipitators are regarded as interesting. There are low cost electric filters under development or available which reach < 50 mg/Nm³. The low efficiency for submicron particles is not very relevant. Flue gas condensation is regarded as an option for improvement if applied before an electric filter.

Nussbaumer: Particulate emissions around 50 mg/Nm³ are still high in comparison to oil and gas and the life cycle assessment is still worse than for gas. To enable a significant improvement, a reduction of particulates by a factor of 10 (e.g. below 5 – 10 mg/Nm³) should be aimed at for biomass combustion. Therefore, fabric filters are regarded as more favorable also by the Swiss Federal Office of Environment.

2.3 Measurements

Question: Are there needs of standardization or needs for improved sampling and measurements?

No discussion due to lack of time.

2.4 Policy

Are there non-technical measures to reduce aerosol immissions from biomass combustion, e.g. policy for funding?

This topic was discussed at the IEA meeting on June 28.

Nussbaumer: There are ongoing activities in Switzerland to improve biomass combustion in practice:

- a) In Switzerland, wood boilers for domestic heating are funded only if they are certified by a facultative type-test which demands for high efficiency and low emissions. As a result, most new boilers are certified boilers.
- b) For new plants > 100 kW a Total Quality Management (TQM) has been implemented to guarantee high quality installations.
- c) To improve the operation of existing plants, a system optimization for automatic furnaces is funded by the Swiss Federal Office of Energy.
- d) As an idea for future funding, the Swiss Federal Office of Environment proposes funding advanced particulate removal such as fabric filters for plants > 1 MW.

2.5 Health

Are there open questions concerning health effects?

Are the immission limit values relevant?

Are health effects of biomass particulates (mainly salts) comparable to other combustion particulates (e.g. soot from Diesel exhaust)?

Are there needs of further investigations?

It was mentioned, that transport and reaction mechanisms may also influence the health effects. This topic was not discussed at the seminar and hence transmission might be part of a presentation at a follow-up seminar.

2.6 Further efforts

Are there needs for further national efforts and potential contribution of the IEA? Is there an interest and need for further information exchange?

This topic was discussed at the IEA meeting on June 28.

The IEA members concluded that aerosols is regarded as a high priority issue. The importance has been shown at the seminar, which was regarded as a good opportunity to get an overview on the state-of-the art and on ongoing activities. Hence a follow-up seminar might be organised by the IEA in maybe 2 years.

While there are many ongoing scientific investigations, there is a lack of developments to reduce aerosols significantly. The interest of industry in this topic is not sufficient. However it is expected that the implementation of more rigid emission limit values (e.g. new TA Luft in Germany) may have severe consequences.

While the first seminar focused on fundamentals, a follow-up seminar should attract industry for contributions and participants.

ACKNOWLEDGMENTS

The support of the International Energy Agency, Bioenergy Task 32, and of the Swiss Federal Office of Energy to the seminar is gratefully acknowledged.